

# Yealink



## Yealink IP Phone User Guide SIP-T19 E2 & T19P E2

Version 81.40  
Feb. 2017

## Copyright

### **Copyright © 2017 YEALINK(XIAMEN) NETWORK TECHNOLOGY CO., LTD**

Copyright © 2017 Yealink(Xiamen) Network Technology CO., LTD. All rights reserved. No parts of this publication may be reproduced or transmitted in any form or by any means, electronic or mechanical, photocopying, recording, or otherwise, for any purpose, without the express written permission of Yealink(Xiamen) Network Technology CO., LTD. Under the law, reproducing includes translating into another language or format.

When this publication is made available on media, Yealink(Xiamen) Network Technology CO., LTD. gives its consent to downloading and printing copies of the content provided in this file only for private use but not for redistribution. No parts of this publication may be subject to alteration, modification or commercial use. Yealink(Xiamen) Network Technology CO., LTD. will not be liable for any damages arising from use of an illegally modified or altered publication.

## Warranty

THE SPECIFICATIONS AND INFORMATION REGARDING THE PRODUCTS IN THIS GUIDE ARE SUBJECT TO CHANGE WITHOUT NOTICE. ALL STATEMENTS, INFORMATION, AND RECOMMENDATIONS IN THIS GUIDE ARE BELIEVED TO BE ACCURATE AND PRESENTED WITHOUT WARRANTY OF ANY KIND, EXPRESS OR IMPLIED. USERS MUST TAKE FULL RESPONSIBILITY FOR THEIR APPLICATION OF PRODUCTS.

YEALINK(XIAMEN) NETWORK TECHNOLOGY CO., LTD. MAKES NO WARRANTY OF ANY KIND WITH REGARD TO THIS GUIDE, INCLUDING, BUT NOT LIMITED TO, THE IMPLIED WARRANTIES OF MERCHANTABILITY AND FITNESS FOR A PARTICULAR PURPOSE. Yealink(Xiamen) Network Technology CO., LTD. shall not be liable for errors contained herein nor for incidental or consequential damages in connection with the furnishing, performance, or use of this guide.

## Declaration of Conformity



Hereby, Yealink(Xiamen) Network Technology CO., LTD. declares that this phone is in conformity with the essential requirements and other relevant provisions of the CE, FCC.

You can find the CE and FCC information from the label on the back of the IP phone.

Statements of compliance can be obtained by contacting [support@yealink.com](mailto:support@yealink.com).

## CE Mark Warning

This device is marked with the CE mark in compliance with EC Directives 2014/35/EU and 2014/30/EU.

### **Part 15 FCC Rules**

Any changes or modifications not expressly approved by the party responsible for compliance could void the user's authority to operate the equipment.

This device complies with Part 15 of the FCC Rules. Operation is subject to the following two conditions:

1. This device may not cause harmful interference, and

2. this device must accept any interference received, including interference that may cause undesired operation.

## Industry Canada (IC)

This Class [B] digital apparatus complies with Canadian ICES-003 Rules.

## Class B Digital Device or Peripheral

Note: This device is tested and complies with the limits for a Class B digital device, pursuant to Part 15 of the FCC Rules.

These limits are designed to provide reasonable protection against harmful interference in a residential installation.

This equipment generates, uses, and can radiate radio frequency energy and, if not installed and used in accordance with the instructions, may cause harmful interference to radio communications. However, there is no guarantee that interference will not occur in a particular installation. If this equipment does cause harmful interference to radio or television reception, which can be determined by turning the equipment off and on, the user is encouraged to try to correct the interference by one or more of the following measures:

1. Reorient or relocate the receiving antenna.
2. Increase the separation between the equipment and receiver.
3. Connect the equipment into an outlet on a circuit different from that to which the receiver is connected.
4. Consult the dealer or an experience radio/TV technician for help.

## WEEE Warning



To avoid the potential effects on the environment and human health as a result of the presence of hazardous substances in electrical and electronic equipment, end users of electrical and electronic equipment should understand the meaning of the crossed-out wheeled bin symbol. Do not dispose of WEEE as unsorted municipal waste and have to collect such WEEE separately.

## Customer Feedback

We are striving to improve our documentation quality and we appreciate your feedback. Email your opinions and comments to [DocsFeedback@yealink.com](mailto:DocsFeedback@yealink.com).

# GNU GPL INFORMATION

Yealink SIP-T19(P) E2 IP phone firmware contains third-party software under the GNU General Public License (GPL). Yealink uses software under the specific terms of the GPL. Please refer to the GPL for the exact terms and conditions of the license.

The original GPL license, source code of components licensed under GPL and used in Yealink products can be downloaded online:

<http://www.yealink.com/GPLOpenSource.aspx?BaseInfoCateId=293&NewsCateId=293&CateId=293>.

## About This Guide

Thank you for choosing the SIP-T19 E2/SIP-T19P E2 (hereinafter referred to as SIP-T19(P) E2) IP phone, exquisitely designed to provide business telephony features, such as Call Hold, Call Transfer, Multicast Paging and Conference over an IP network. The difference between the SIP-T19 E2 and SIP-T19P E2 IP phones is that only SIP-T19P E2 supports PoE.

This guide provides everything you need to quickly use your new phone. First, verify with your system administrator that the IP network is ready for phone configuration. Also be sure to read the Packaging Contents and Regulatory Notices sections in this guide before you set up and use the SIP-T19(P) E2 IP phone.

**Note**

Network Directory and Network Call Log features are hidden for IP phones in neutral firmware, which are designed for the BroadWorks environment. Please contact your system administrator for more information.

## In This Guide

Topics provided in this guide include:

- Chapter 1 [Overview](#)
- Chapter 2 [Getting Started](#)
- Chapter 3 [Customizing Your Phone](#)
- Chapter 4 [Basic Call Features](#)
- Chapter 5 [Advanced Phone Features](#)

## Summary of Changes

This section describes the changes to this guide for each release and guide version.

## Changes for Release 81, Guide Version 81.40

Major updates have occurred to the following sections:

- [Entering Data and Editing Fields](#) on page 18
- [Remote Phone Book](#) on page 43
- [Auto Answer](#) on page 70
- [Do Not Disturb \(DND\)](#) on page 76
- [Call Forward](#) on page 78

- [Call Park/Retrieve](#) on page 88
- [Multicast Paging](#) on page 103

## Changes for Release 81, Guide Version 81.20

None

## Changes for Release 81, Guide Version 81.15

The contents in the following section are removed to [Frequently Asked Questions on Yealink IP Phones](#).

- Troubleshooting

Major updates have occurred to the following sections:

- [Intercom](#) on page 101
- [Multicast Paging](#) on page 103

## Changes for Release 81, Guide Version 81.10

The following sections are new:

- [Key Tone](#) on page 31
- [Call Park](#) on page 88

Major updates have occurred to the following sections:

- [Basic Network Settings](#) on page 16
- [Language](#) on page 22
- [Phone Lock](#) on page 25
- [Volume](#) on page 28
- [Programable Keys](#) on page 51
- [Dial Plan](#) on page 57
- [Call Mute](#) on page 73
- [Do Not Disturb \(DND\)](#) on page 76
- [Call Transfer](#) on page 81
- [Intercom](#) on page 101
- [Multicast Paging](#) on page 103

## Changes for Release 80, Guide Version 80.95

The following section is new:

- [Entering Data and Editing Fields](#) on page 18

Major updates have occurred to the following sections:

- [Icon Instructions](#) on page 3
- [Optional Accessories](#) on page 10
- [Phone Installation](#) on page 11
- [Appendix](#) on page 129

# Table of Contents

## **About This Guide ..... v**

In This Guide .....	v
Summary of Changes .....	v
Changes for Release 81, Guide Version 81.40 .....	v
Changes for Release 81, Guide Version 81.20 .....	vi
Changes for Release 81, Guide Version 81.15 .....	vi
Changes for Release 81, Guide Version 81.10 .....	vi
Changes for Release 80, Guide Version 80.95 .....	vii

## **Table of Contents..... viii**

## **Overview ..... 1**

Hardware Component Instructions .....	1
Icon Instructions .....	3
Feature Status Icons.....	3
Other Icons.....	4
LED Instructions.....	4
User Interfaces .....	5
Phone User Interface.....	5
Web User Interface.....	6
Documentations.....	8

## **Getting Started..... 9**

Packaging Contents .....	9
Optional Accessories.....	10
Phone Installation .....	11
Phone Initialization.....	14
Phone Status.....	14
Basic Network Settings.....	16
Registration .....	17
Idle Screen .....	18
Entering Data and Editing Fields.....	18

## **Customizing Your Phone..... 21**

General Settings .....	21
Contrast .....	21



Language.....	22
Time & Date.....	22
Administrator Password.....	24
Key As Send.....	25
Phone Lock.....	25
Audio Settings.....	28
Volume.....	28
Ring Tones.....	29
Key Tone.....	31
Contact Management.....	31
Directory.....	32
Local Directory.....	33
Blacklist.....	42
Remote Phone Book.....	43
Call History Management.....	45
Viewing History Records.....	45
Placing a Call from History Records.....	46
Adding a Contact to the Local Directory/Blacklist.....	46
Deleting History Records.....	46
Disabling History Record.....	47
Search Source List in Dialing.....	47
System Customizations.....	49
Logo Customization.....	49
Headset Use.....	49
Programable Keys.....	51
Account Registration.....	57
Dial Plan.....	57
Emergency Number.....	62
Live Dialpad.....	63
Hotline.....	64
<b>Basic Call Features.....</b>	<b>65</b>
Placing Calls.....	65
Answering Calls.....	67
Ending Calls.....	68
Redialing Numbers.....	68
Recent Call In Dialing.....	69
Auto Answer.....	70
Auto Redial.....	71
Call Completion.....	72
ReCall.....	73
Call Mute.....	73
Muting a Call.....	74
Muting While Dialing.....	74

Call Hold/Resume .....	75
Do Not Disturb (DND).....	76
Call Forward .....	78
Static Forwarding .....	78
Dynamic Forwarding .....	81
Call Transfer.....	81
Blind Transfer.....	82
Semi-attended Transfer.....	84
Attended Transfer.....	84
Call Waiting .....	85
Conference .....	86
Local Conference .....	86
Network Conference.....	87
Call Park/Retrieve.....	88
FAC Mode .....	89
Transfer Mode.....	91
Call Pickup .....	92
Directed Call Pickup.....	93
Group Call Pickup .....	94
Anonymous Call .....	96
Anonymous Call Rejection .....	97
<b>Advanced Phone Features.....</b>	<b>99</b>
Hot Desking .....	99
Intercom .....	101
Configuring the Intercom Feature on the IP Phone.....	101
Using Intercom .....	103
Multicast Paging.....	103
Sending RTP Stream .....	104
Receiving RTP Stream .....	106
Using Multicast Paging.....	108
Music on Hold (MoH).....	109
Shared Call Appearance (SCA).....	110
Configuring SCA Feature on the IP Phone .....	111
Using SCA Feature on the IP Phone .....	114
Bridged Line Appearance (BLA).....	115
Configuring BLA Feature on the IP Phone.....	116
Using BLA Feature on the IP Phone.....	119
Messages.....	120
Short Message Service (SMS).....	120
Voice Mail .....	122
Message Waiting Indicator (MWI) .....	124
<b>Regulatory Notices .....</b>	<b>127</b>

Service Agreements .....127

Limitations of Liability .....127

Safety Instructions .....127

**Appendix.....129**

Appendix A - Time Zones .....129

Appendix B - Menu Structure.....131

**Index .....133**



# Overview

This chapter provides the overview of the SIP-T19(P) E2 IP phone. Topics include:

- [Hardware Component Instructions](#)
- [Icon Instructions](#)
- [LED Instructions](#)
- [User Interfaces](#)
- [Documentations](#)





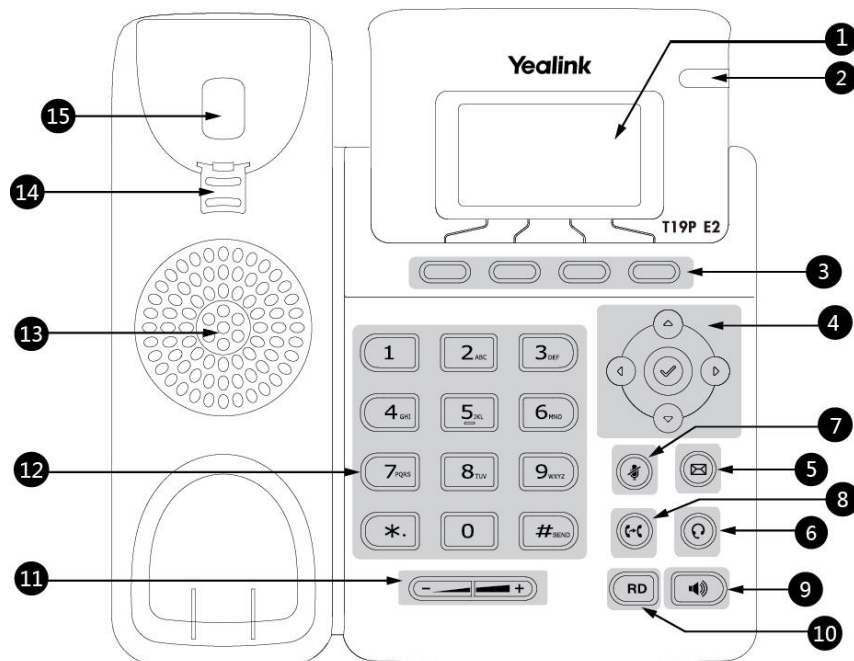

If you require additional information or assistance with your new phone, contact your system administrator.

## Hardware Component Instructions

The main hardware components of the SIP-T19(P) E2 IP phone are the LCD screen and the keypad.



















Hardware component instructions of the SIP-T19(P) E2 IP phone are:





	Item	Description
①	LCD Screen	Shows information about calls, messages, soft keys, time, date and other relevant data: <ul style="list-style-type: none"> <li>• Default account</li> <li>• Call information—caller ID, call duration</li> <li>• Icons (for example, )</li> <li>• Missed call text or second incoming caller information</li> <li>• Prompt text (for example, "Saving config file!")</li> <li>• Time and date</li> </ul>
②	Power Indicator LED	Indicates call status, message status and phone's system status: <ul style="list-style-type: none"> <li>• Receives an incoming call—Fast-flashing</li> <li>• Receives a voice mail or text message—Slow-flashing</li> </ul>
③	Soft Keys	Label automatically to identify their context-sensitive features.
④		Scroll through the displayed information.
		Confirms actions or answers incoming calls.
⑤	 (Message Key)	Accesses voice mails.
⑥	 (Headset Key)	Toggles the headset mode.
⑦	 (Mute Key)	Mutes or un-mutes an active call.
⑧	 (Transfer Key)	Transfers a call to another party.
⑨	Speakerphone Key	Toggles the hands-free (speakerphone) mode.
⑩	RD Key	Redials a previously dialed number.
⑪	Volume Key	Adjusts the volume of the handset, headset, speaker or ringer.
⑫	Keypad	Provides the digits, letters and special characters in context-sensitive applications.
⑬	Speaker	Provides hands-free (speakerphone) audio output.
⑭	Hookswitch Tab	Secures the handset in the handset cradle when the IP phone is mounted vertically. For more information on how to adjust the hookswitch tab, refer to <a href="#">Yealink Wall Mount Quick Installation Guide for Yealink IP Phones</a> .
⑮	Hookswitch	<ul style="list-style-type: none"> <li>• Picking up the handset from the handset cradle, the hookswitch bounces and the phone connects to the line.</li> <li>• Laying the handset down on the handset cradle, the phone disconnects from the line.</li> </ul>

## Icon Instructions

### Feature Status Icons





Icons appearing on the status bar are described in the following table:

Icons	Description
	Network is unavailable
	The private line registers successfully
	Register failed
	Registering
	The shared/bridged line registers successfully
	Hands-free (speakerphone) mode
	Handset mode
	Headset mode
	Voice Mail
	Text Message
	Auto Answer
	Do Not Disturb (DND)
	Ringer volume is 0
	Phone Lock
	Keep Mute
	Missed Calls

Icons	Description
	Call Forward
	The ACD state is available
 and x	The ACD state is unavailable
	The ACD state is Wrap up
	Log out of the ACD system

## Other Icons

**Icon indicator** (associated with call history)

Icons	Description
	Missed Calls
	Placed Calls
	Received Calls
	Forwarded Calls

**Icon indicator** (associated with contact)

Icons	Description
	The contact icon

## LED Instructions

**Power Indicator LED**

LED Status	Description
Solid yellow	The phone is initializing.
Fast-flashing yellow (300ms)	The phone is ringing.



LED Status	Description
Slow-flashing yellow (1s)	The phone receives a voice mail or text message.
Off	<p>The phone is powered off.</p> <p>The phone is idle.</p> <p>The phone is busy.</p> <p>The call is placed on hold or is held.</p> <p>The call is muted.</p>

**Note**

The above introduces the default LED status. The status of the power indicator LED is configurable via web user interface. For more information, contact your system administrator.

## User Interfaces

Two ways to customize configurations of your SIP-T19(P) E2 IP phone:

- The user interface on the IP phone.
- The user interface in a web browser on your PC.

The hardware components keypad and LCD screen constitute the phone user interface, which allows the user to execute all call operation tasks and basic configuration changes directly on the phone. In addition, you can use the web user interface to access all configuration settings. In many cases, either the phone user interface and/or the web user interface interchangeably. However, in some cases, it is only possible to use one or the other interface to operate the phone and change settings.

## Phone User Interface

You can customize your phone by pressing the **Menu** soft key to access the phone user interface. The Advanced Settings option is only accessible to the administrator, and the default administrator password is "admin" (case-sensitive). For more information on customizing your phone with the available options from the phone user interface, refer to [Customizing Your Phone](#) on page 21.

**Note**

For a better understanding of the menu structure, please refer to [Appendix B - Menu Structure](#) on page 131.

## Web User Interface

In addition to the phone user interface, you can also customize your phone via web user interface. In order to access the web user interface, you need to know the IP address of your new phone. To obtain the IP address, press the  key on the phone when the phone is idle. Enter the IP address (e.g., http://192.168.0.10 or 192.168.0.10 for IPv4; http://[2005:1:1:1:215:65ff:fe64:6e0a] or [2005:1:1:1:215:65ff:fe64:6e0a] for IPv6) in the address bar of a web browser on your PC. The default administrator user name and password are both "admin" (case-sensitive).

### Note

The access to the Advanced settings of the Account or Network via web user interface may be blocked by the web browser (e.g., Chrome, Firefox) if you have installed "Adblock Plus plugin".

The options you can use to customize the IP phone via phone user interface and/or via web user interface are listed in the following table:

Options	Phone User Interface	Web User Interface
<b>Status</b>		
--IPv4		
--MAC Address		
--Firmware	✓	✓
--Network		
--Phone		
--Accounts		
<b>Basic Phone Settings</b>		
--Contrast	✓	
--Language	✓	
--Time & Date	✓	
--Administrator Password	✓	
--Key As Send	✓	
--Phone Lock	✓	
--Ring Tones	✓	
--Key Tone	✓	✓
--Contact Management		
--Directory	x	
--Local Directory	✓	
--Blacklist	✓	
--Remote Phone Book	x	
--Call History Management	✓	
--Search Source List in Dialing	x	
--Logo Customization	x	

Options	Phone User Interface	Web User Interface
--Headset Use	✓	
--Programable Keys	x	
--Account Registration	✓	
--Dial Plan	x	
--Emergency Number	x	
--Live Dialpad	x	
--Hotline	✓	
<b>Basic Call Features</b>		
--Recent Call In Dialing	x	
--Auto Answer	✓	
--Auto Redial	✓	
--Call Completion	✓	
--ReCall	x	
--Do Not Disturb (DND)	✓	
--Call Forward	✓	✓
--Call Transfer	✓	
--Call Waiting	✓	
--Conference	x	
--Call Park		
--Call Pickup	✓	
--Anonymous Call	✓	
--Anonymous Call Rejection	✓	
<b>Advanced Phone Features</b>		
--Hot Desking	✓	
--Intercom	✓	
--Multicast Paging	x	✓
--Shared Call Appearance (SCA)	x	
--Bridged Line Appearance (BLA)	x	
--Music on Hold	x	
--Messages	✓	
<b>SIP Account</b>		
--User Options		
--Activation	✓	
--Label	✓	
--Display Name	✓	
--Register Name	✓	✓
--User Name	✓	
--Password	✓	
--Server Option		
--SIP Server 1/2	✓	

Options	Phone User Interface	Web User Interface
--Register Port	x	
--Outbound Status	√	
--Outbound Proxy1/2	√	
--Fallback Interval	√	
--NAT Status	√	

**Note** The table above lists most of the feature options. Please refer to the relevant sections for more information.

## Documentations

The following table shows documentations available for the SIP-T19(P) E2 IP phone.

Name	Contents	Where found	Language
Quick Start Guide	Basic call features and phone customizations	In the package	English
		On the website	English/Chinese
User Guide	Phone/Web user interface settings Basic call features and advanced phone features	On the website	English/Chinese

**Note** You can also download the latest documentations online:  
<http://support.yealink.com/documentFront/forwardToDocumentDetailPage?documentId=78>.

## Getting Started

This chapter provides basic installation instructions and information for obtaining the best performance with the SIP-T19(P) E2 IP phone. Topics include:

- [Packaging Contents](#)
- [Phone Installation](#)
- [Phone Initialization](#)
- [Phone Status](#)
- [Basic Network Settings](#)
- [Registration](#)
- [Idle Screen](#)
- [Entering Data and Editing Fields](#)

If you require additional information or assistance with your new phone, contact your system administrator.

## Packaging Contents

The following components are included in your SIP-T19(P) E2 IP phone package:

- **SIP-T19(P) E2 IP Phone**

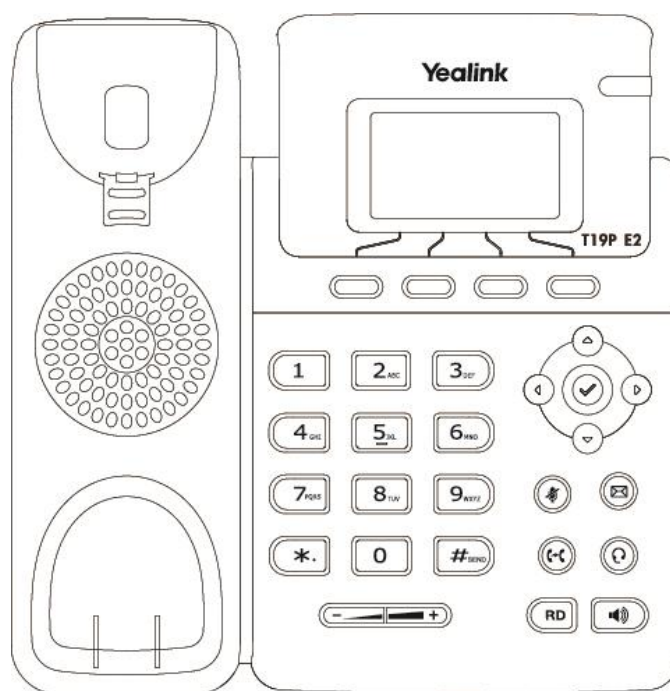

- **Phone Stand**



- **Handset & Handset Cord**

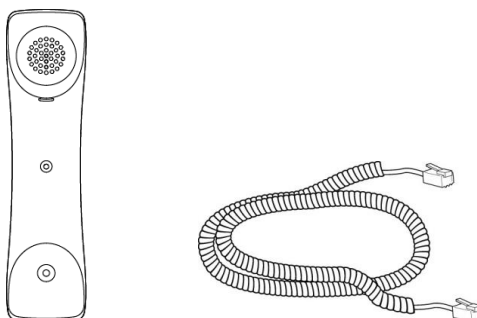

- **Ethernet Cable**

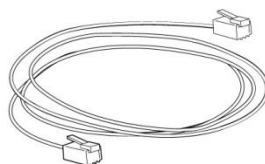

- **Quick Start Guide**

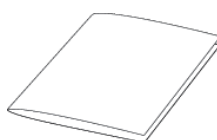

Check the list before installation. If you find anything missing, contact your system administrator.

## Optional Accessories

The following items are optional accessories for your SIP-T19(P) E2 IP phone. You need to purchase them separately if required.

- **Power Adapter (5.5mm DC plug)**

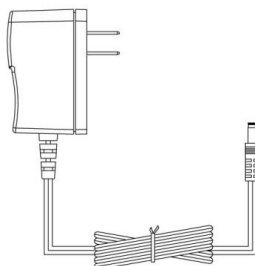

- **Headset YHS32/YHS33**

**Note**

We recommend that you use the accessories provided or approved by Yealink. The use of unapproved third-party accessories may result in reduced performance.

## Phone Installation

If your phone is already installed, proceed to [Phone Initialization](#) on page 14.

This section introduces how to install the phone:

- 1) Attach the stand
- 2) Connect the handset and optional headset
- 3) Connect the network and power

### 1) Attach the stand

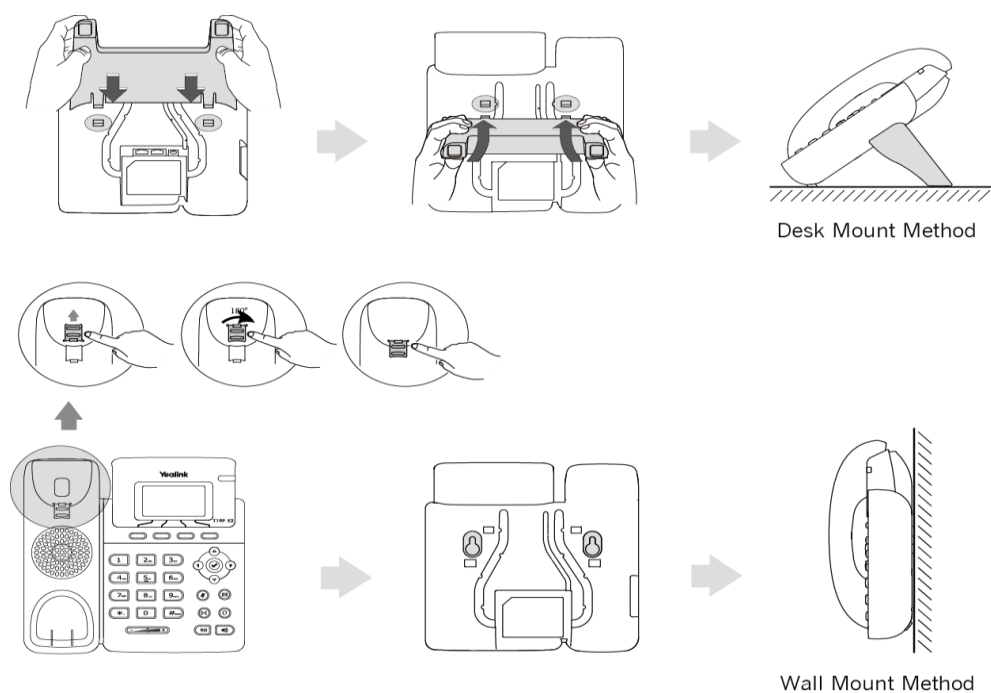

#### Note

The hookswitch tab has a lip which allows the handset to stay on-hook when the IP phone is mounted vertically.

### 2) Connect the handset and optional headset

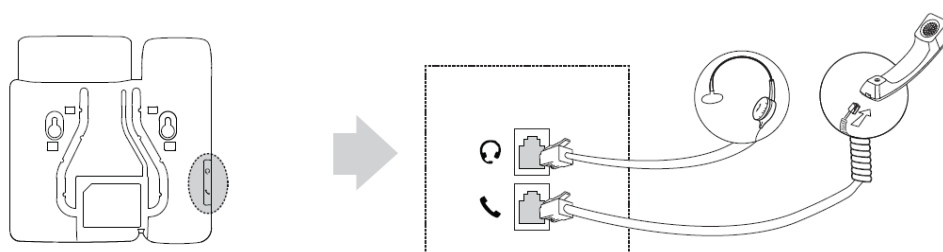

### 3) Connect the network and power

You have two options for power and network connections. Your system administrator will advise you which one to use.

- AC power
- Power over Ethernet (PoE)

#### Note

PoE is not applicable to the SIP-T19 E2 IP phone.



## AC Power

### To connect the AC power:

1. Connect the DC plug on the power adapter to the DC5V port on the phone and connect the other end of the power adapter into an electrical power outlet.
2. Connect the included or a standard Ethernet cable between the Internet port on the phone and the one on the wall or switch/hub device port.

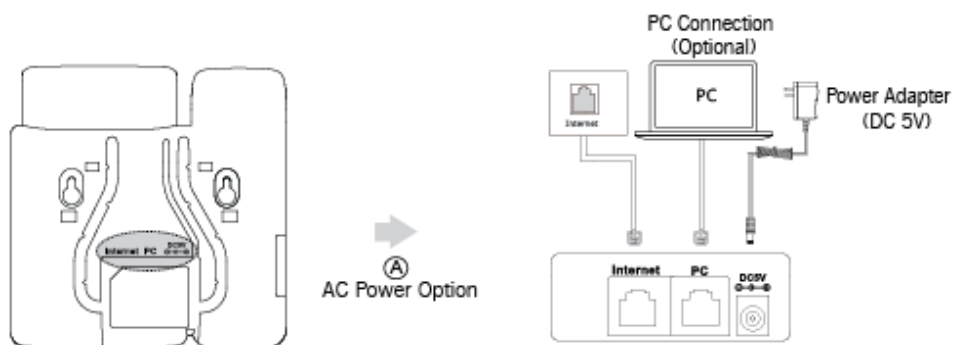

### Note

The IP phone should be used with Yealink original power adapter (5V/600mA) only. The use of the third-party power adapter may cause the damage to the phone.

## Power over Ethernet

With the included or a regular Ethernet cable, the SIP-T19P E2 IP phone can be powered from a PoE-compliant switch or hub.

**To connect the PoE for the SIP-T19P E2 IP phone:**

1. Connect the Ethernet cable between the Internet port on the phone and an available port on the in-line power switch/hub.

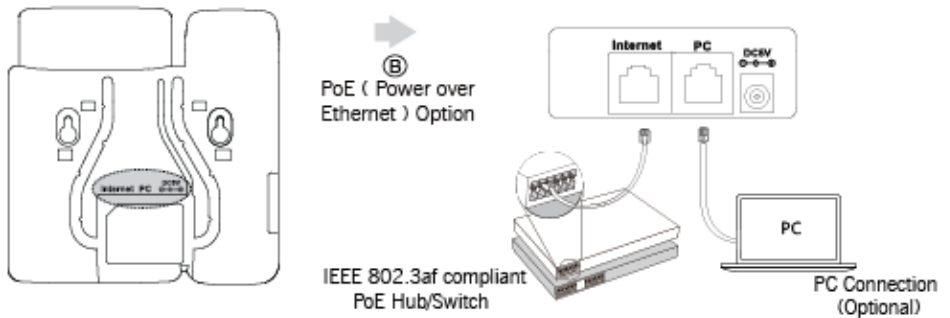

**Note**

If in-line power is provided, you don't need to connect the phone to the power adapter. Make sure the switch/hub is PoE-compliant.

The phone can also share the network with another network device such as a PC (personal computer). This is an optional connection. We recommend that you use the Ethernet cable provided by Yealink. The PC port may be disabled, contact your system administrator for more information.

**Important!** Do not remove power from the phone while it is updating firmware and configurations.

## Phone Initialization

After your phone is powered on, the system boots up and performs the following steps:

**Automatic Phone Initialization**

The phone finishes the initialization by loading the saved configuration. The LCD screen displays "Welcome Initializing...please wait" during this process.

**DHCP (Dynamic Host Configuration Protocol)**

The phone attempts to contact a DHCP server in your network to obtain valid IPv4 network settings (e.g., IP address, subnet mask, default gateway address and DNS address) by default.

**Note**

If your network does not use DHCP, proceed to [Basic Network Settings](#) on page 16.

## Phone Status



You can view phone status via phone user interface or web user interface.

Available information of phone status includes:

- Network status (IPv4 status or IPv6 status, IP mode and MAC address).
  - IPv4 uses a 32-bit address.

- IPv6 is an updated version of the current Internet Protocol to meet the increased demands for unique IP addresses, using a 128-bit address.
- Phone status (product name, hardware version, firmware version, product ID, MAC address and device certificate status).
- Account status (register status of SIP accounts).

**To view the phone status via phone user interface:**

1. Press  , or press **Menu->Status**.
2. Press  or  to scroll through the list and view the specific information.

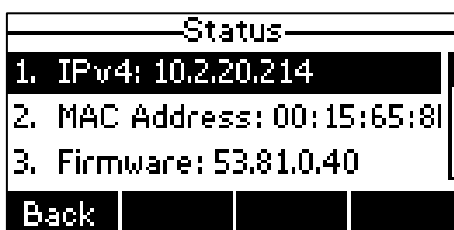

**To view the phone status via web user interface:**

1. Open a web browser of your computer.
2. Enter the IP address in the browser's address bar, and then press the **Enter** key.  
(e.g., "http://192.168.0.10" for IPv4 or "http://[2005:1:1:1:215:65ff:fe64:6e0a]" for IPv6).
3. Enter the user name (admin) and password (admin) in the login page.

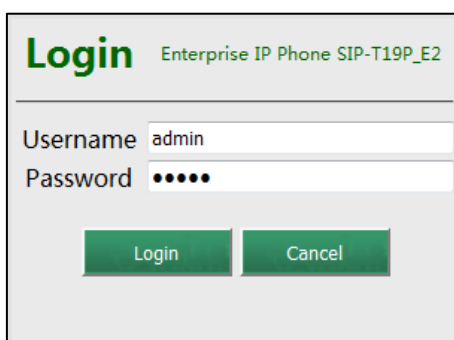

4. Click **Login** to login.

The phone status is displayed on the first page of the web user interface.

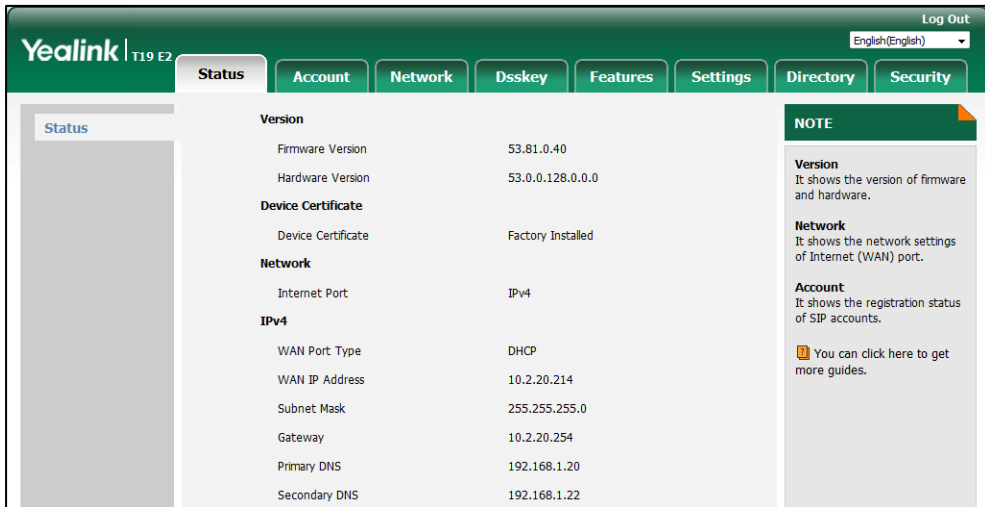

**Note** If IP mode of the phone is configured as **IPv4 & IPv6**, you can enter either of them in the browser's address bar to view the phone status. IPv6 is not available on all servers. Contact your system administrator for more information.

## Basic Network Settings

If your phone cannot contact a DHCP server for any reason, you need to configure network settings manually. The IP phone can support either or both IPv4 and IPv6 addresses.

### To configure the IP mode via phone user interface:

1. Press **Menu**->**Settings**->**Advanced Settings** (default password: admin)  
->**Network**->**WAN Port**.
2. Press or to select **IPv4**, **IPv6** or **IPv4 & IPv6** from the **IP Mode** field.

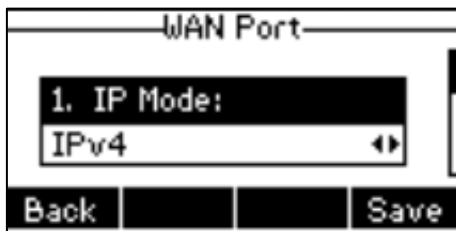



3. Press the **Save** soft key to accept the change or the **Back** soft key to cancel.

You can configure a static IPv4 address for the IP phone. Before configuring it, make sure that the IP mode is configured as **IPv4** or **IPv4 & IPv6**.

### To configure a static IPv4 address via phone user interface:

1. Press **Menu**->**Settings**->**Advanced Settings** (default password: admin)  
->**Network**->**WAN Port**.

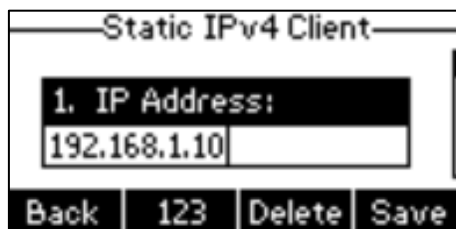

2. Press  to select the **IPv4** and then press the **Enter** soft key.
3. Press  to select **Static IPv4 Client** and then press the **Enter** soft key.
4. Enter the desired value in the **IP Address**, **Subnet Mask**, **Default Gateway**, **Pri.DNS** and **Sec.DNS** field respectively.



5. Press the **Save** soft key to accept the change or the **Back** soft key to cancel.

You can configure a static IPv6 address for the IP phone. Before configuring it, make sure that the IP mode is configured as **IPv6** or **IPv4 & IPv6**.

#### To configure a static IPv6 address via phone user interface:

1. Press **Menu**->**Settings**->**Advanced Settings** (default password: admin)  
->**Network**->**WAN Port**.
2. Press  to select **IPv6** and then press the **Enter** soft key.
3. Press  to select **Static IPv6 Client** and then press the **Enter** soft key.
4. Enter the desired value in the **IP Address**, **IPv6 IP Prefix**, **Default Gateway**, **Pri.DNS** and **Sec.DNS** field respectively.



5. Press the **Save** soft key to accept the change or the **Back** soft key to cancel.

#### Note

The wrong network settings may result in inaccessibility of your phone and may also have an impact on your network performance. For more information on these parameters, contact your system administrator.

## Registration

Generally, your phone will be deployed with multiple other phones. In this case, your system administrator will configure the phone parameters beforehand, so that after you start up your phone, the phone will be registered and ready for use. The SIP-T19(P) E2 IP phone supports only one account. If your phone is not registered, you may have to register it. For more information on how to register your phone, refer to [Account Registration](#) on page 57.

## Idle Screen

If the phone has successfully started up, the idle LCD screen will be displayed as below.

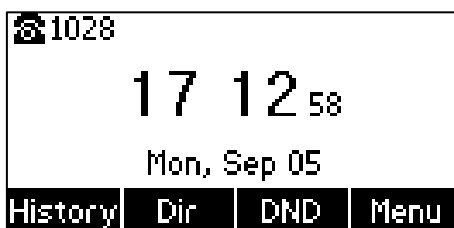

The idle screen displays the label of default account, time and date, and four soft keys.

### Note

You can configure the phone not to display the label of default account, contact your system administrator for more information.







## Entering Data and Editing Fields

You can enter data and edit fields using the phone keypad.

Keypad on the phone provides different characters (or numbers) when using the **2aB**, **abc**, **Abc**, **ABC** or **123** input mode. You can change the following input modes to enter data and edit fields on your phone. When your phone keypad matches the input mode, you can press the keypad repeatedly to view the character (or number) options and stop to select. When the character (or number) you want to enter displays in the field, wait for one second, and enter the next character (or number).





The following table lists the input modes and character (or number) options for the keypad:









Input Mode Keypad	2aB	abc	Abc (initials in capitals)	ABC	123
	1				1
	2abcABC	abc2äæååå ååç	abc2äæååå ååç	ABC2ÄÆÅ ÅÅÅÇ	2
	3defDEF	def3èéëëë ëëëö	def3èéëëë ëëëö	DEF3ÉÊËËË ËËËÖ	3
	4ghiGHI	ghi4ïîï ïïï	ghi4ïîï ïïï	GHI4ÏÎÎ ÏÎÎ	4
	5jklJKL	jkl5£	jkl5£	JKL5£	5
	6mnoMNO	mno6öøòó	mno6öøòó	MNO6ÖØ	6

<b>Input Mode</b> <b>Keypad</b>	<b>2aB</b>	<b>abc</b>	<b>Abc</b> <b>(initials in capitals)</b>	<b>ABC</b>	<b>123</b>
		ôõñ	ôõñ	ÒÓÔÕÑ	
	7pqrsPQRS	pqrs7ßS	pqrs7ßS	PQRS7S	7
	8tuvTUV	tuv8ùúûü	tuv8ùúûü	TUV8ÙÚÛÜ Ü	8
	9wxyzWXYZ Z	wxyz9ýþ	wxyz9ýþ	WXYZ9ÝÞ	9
	0	space	space	space	0
	*,?!\\-()@/: _+&%=<> £ \$¥¤[]{}~ ^_`\$#`	*,?!\\-()@/: _+&%=<> £ \$¥¤[]{}~ ^_`\$#`	*,?!\\-()@/: _+&%=<> £ \$¥¤[]{}~ ^_`\$#`	*,?!\\-()@/: _+&%=<> £ \$¥¤[]{}~ ^_`\$#`	./@[]
	#	#	#	#	#

**To enter or edit data:**

Do one of the following:

<b>If you want to</b>	<b>Then you can</b>
Enter only digits (1), uppercase (A) characters, lowercase (a) characters, or alphanumeric (2aB) characters.	<p>Press a keypad key one or more times (depending on what input mode you're in) to enter the characters that is displayed on the keypad key.</p> <p>You can press the <b>abc</b> soft key one or more times to switch among uppercase (<b>ABC</b> soft key), numeric (<b>123</b> soft key), alphanumeric (<b>2aB</b> soft key), uppercase and lowercase (<b>Abc</b> soft key) and lowercase (<b>abc</b> soft key) input modes.</p> <p>For example, if the input mode is <b>ABC</b>:</p> <ul style="list-style-type: none"> <li>- To enter "A", press  once.</li> <li>- To enter "B", press  twice quickly.</li> <li>- To enter "C", press  three times quickly.</li> <li>- To enter "2ÄÆÄÄÄÄÇ", press  more than three times quickly.</li> </ul> <p>Note: When you are in the uppercase (<b>ABC</b> soft key), uppercase and lowercase (<b>Abc</b> soft key) or</p>

If you want to	Then you can
	lowercase ( <b>abc</b> soft key) input mode, 1 is not available.
Enter special characters.	<p>Press the keypad key  or , or press .</p> <p><b>For  Key:</b></p> <ul style="list-style-type: none"> <li>- If it is in the uppercase (<b>ABC</b> soft key), uppercase and lowercase (<b>Abc</b> soft key) or lowercase (<b>abc</b> soft key) input mode, it will provide the space character.</li> <li>- If it is in the numeric (<b>123</b> soft key) or alphanumeric (<b>2aB</b> soft key) input mode, it will only provide the digit <b>0</b>.</li> <li>- If it is in the numeric (<b>123</b> soft key) or alphanumeric (<b>2aB</b> soft key) input mode, it will provide the special character + by long pressing about 2 seconds on the dialing/pre-dialing screen.</li> </ul> <p><b>For  key:</b></p> <ul style="list-style-type: none"> <li>- It only provides the pound character #.</li> </ul> <p><b>For  key:</b></p> <ul style="list-style-type: none"> <li>- If it is in the uppercase (<b>ABC</b> soft key), lowercase (<b>abc</b> soft key), uppercase and lowercase (<b>Abc</b> soft key) or alphanumeric (<b>2aB</b> soft key) input mode, it will provide the following special characters:  <b>*.?!\-\()@/!,:;+&amp;%=&lt;&gt; £ \$ ¥ ¢ [] {} ~ ^ _ ¡ ¢ \$ # "  </b></li> <li>- If it is in the numeric (<b>123</b> soft key) input mode, it will provide the following special characters: <b>.*:/@[]</b>.</li> </ul>
Delete text you entered.	Press  or  to position the cursor to the right of the text you want to delete, and then press the <b>Delete</b> soft key to delete one character at a time.



## Customizing Your Phone

You can customize your SIP-T19(P) E2 IP phone by personally configuring certain settings, for example, contrast, language and time & date. You can add contacts to the phone's local directory manually or from call history. You can also personalize different ring tones for different callers.

This chapter provides basic operating instructions for customizing your phone. Topics include:

- [General Settings](#)
- [Audio Settings](#)
- [Contact Management](#)
- [Call History Management](#)
- [Search Source List in Dialing](#)
- [System Customizations](#)



If you require additional information or assistance with your new phone, contact your system administrator.

## General Settings

### Contrast

You can configure the LCD screen contrast of SIP-T19(P) E2 to a comfortable level. The intensity of contrast ranges from 1 to 10 and the highest intensity is 10.

**To configure the contrast via phone user interface:**

1. Press **Menu**->**Settings**->**Basic Settings**->**Display**->**Contrast**.
2. Press  or , or the **Switch** soft key to increase or decrease the intensity of contrast. The default contrast level is "6".

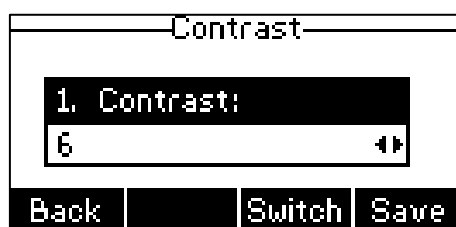



3. Press the **Save** soft key to accept the change or the **Back** soft key to cancel.

Contrast is configurable via web user interface at the path **Settings**->**Preference**.

## Language

The default language of the phone user interface is English. If the language of your web browser is not supported by the phone, the web user interface will use English by default. You can change the language for the phone user interface and the web user interface respectively.

### To change the language for the phone user interface:

1. Press **Menu->Settings->Basic Settings->Language**.
2. Press  or  to select the desired language.



3. Press the **Save** soft key to accept the change.

Text displayed on the phone user interface will change to the selected language.

### To change the language for the web user interface:

1. Select the desired language from the pull-down list at the top-right corner of web user interface.





Text displayed on the web user interface will change to the selected language.

## Time & Date

The time and date are displayed on the LCD screen when the phone is idle. You can configure the phone to obtain the time and date from the SNTP server automatically, or configure the time and date manually. If the phone cannot obtain the time and date from the Simple Network Time Protocol (SNTP) server, contact your system administrator for more information.

### To configure the SNTP settings via phone user interface:

1. Press **Menu->Settings->Basic Settings->Time & Date->SNTP Settings**.
2. Press  or , or the **Switch** soft key to select the time zone that applies to your area

from the **Time Zone** field.

The default time zone is "+8".

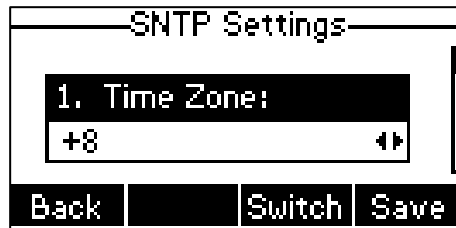

3. Enter the domain name or IP address of SNTP server in the **NTP Server1** and **NTP Server2** field respectively.
4. Press  $\leftarrow$  or  $\rightarrow$ , or the **Switch** soft key to select the desired value from the **Daylight Saving** field.
5. Press  $\leftarrow$  or  $\rightarrow$ , or the **Switch** soft key to select the desired time zone name from the **Location** field.

This field appears only if **Daylight Saving** field is selected to **Automatic**.

The default time zone name is "China(Beijing)".

6. Press the **Save** soft key to accept the change or the **Back** soft key to cancel.

#### Note

Please refer to [Appendix A - Time Zones](#) for the list of available time zones on the IP phone.

#### To configure the time and date manually via phone user interface:

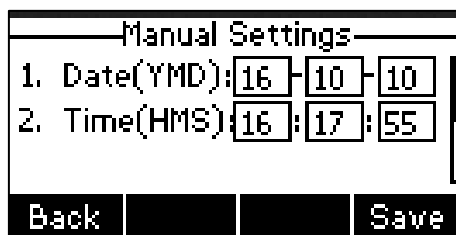

1. Press **Menu->Settings->Basic Settings->Time & Date->Manual Settings**.
2. Enter the specific date in the **Date(YMD)** field.
3. Enter the specific time in the **Time(HMS)** field.





4. Press the **Save** soft key to accept the change.  
The date and time displayed on the LCD screen will change accordingly.

#### To configure the time and date format via phone user interface:

1. Press **Menu->Settings->Basic Settings->Time & Date->Time & Date Format**.

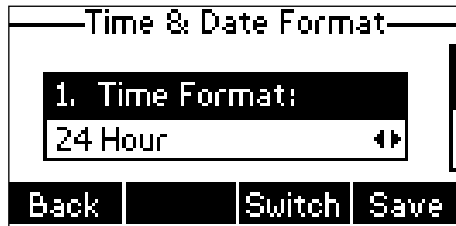
- Press  or , or the **Switch** soft key to select the desired time format (**12 Hour** or **24 Hour**) from the **Time Format** field.



- Press  or , or the **Switch** soft key to select the desired date format from the **Date Format** field.
- Press the **Save** soft key to accept the change or the **Back** soft key to cancel.

There are 7 available date formats. For example, for the date format “WWW DD MMM”, “WWW” represents the abbreviation of the weekday, “DD” represents the two-digit day, and “MMM” represents the first three letters of the month.

The date formats available:

Date Format	Example (2016-09-02)
WWW MMM DD	Fri, Sep 02
DD-MMM-YY	02-Sep-16
YYYY-MM-DD	2016-09-02
DD/MM/YYYY	02/09/2016
MM/DD/YY	09/02/16
DD MMM YYYY	02 Sep, 2016
WWW DD MMM	Fri, 02 Sep

Time and date are configurable via web user interface at the path **Settings->Time & Date**.

**Note**

You can also customize the date format. Contact your system administrator for more information.

## Administrator Password

The Advanced Settings option is only accessible to the administrator. The default administrator password is “admin”. For security reasons, you should change the default administrator password as soon as possible.

**To change the administrator password via phone user interface:**

- Press **Menu->Settings->Advanced Settings** (default password: admin) ->**Change Password**.

2. Enter the current password in the **Old PWD** field.

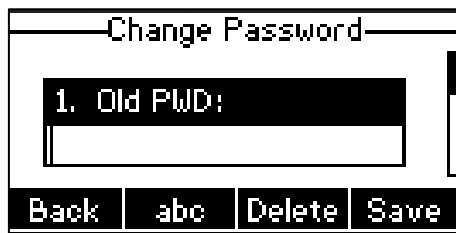

3. Enter the new password in the **New PWD** field.
4. Re-enter the new password in the **Confirm PWD** field.
5. Press the **Save** soft key to accept the change or the **Back** soft key to cancel.

Administrator password is configurable via web user interface at the path **Security->Password**.

## Key As Send

You can set the “#” key or “\*” key to perform as a send key while dialing.

**To configure key as send via phone user interface:**

1. Press **Menu->Features->Key As Send**.
2. Press  $\leftarrow$  or  $\rightarrow$ , or the **Switch** soft key to select # or \* from the **Key As Send** field, or select **Disabled** to disable this feature.

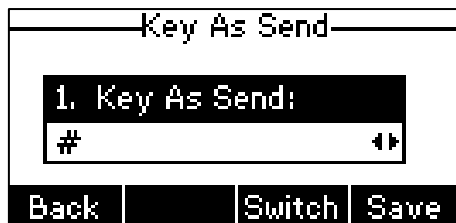

3. Press the **Save** soft key to accept the change or the **Back** soft key to cancel.

Key as send is configurable via web user interface at the path **Features->General Information**.

## Phone Lock

You can lock your phone temporarily when you are not using it. This feature helps to protect your phone from unauthorized use.

Phone lock consists of the following:



- Menu Key:** The **Menu** soft key is locked. You cannot access the menu of the phone until unlocked.
- Function Keys:** The function keys are locked. You cannot use the Message, RD, Mute, Transfer,  $\checkmark$ , navigation keys and soft keys until unlocked.
- All Keys:** All keys are locked except the Volume key, digit keys, # key, \* key,

Headset key and Speakerphone key. You are only allowed to dial emergency numbers, reject incoming calls by pressing the **Reject** soft key, answer incoming calls by lifting the handset, pressing the Speakerphone key, the HEADSET key, the  key, or the **Answer** soft key, and end the call by hanging up the handset, pressing the Speakerphone key or the **EndCall** soft key.



**Note**

The emergency number setting, if desired, must be set before lock activation. For more information, refer to [Emergency Number](#) on page 62.

**To activate the phone lock via phone user interface:**

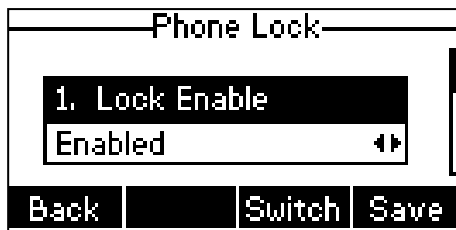
1. Press **Menu->Settings->Basic Settings->Phone Lock**.
2. Enter the desired PIN (default PIN: 123) in the **Unlock PIN** field, and then press the **OK** soft key.
3. Press  or , or the **Switch** soft key to select **Enabled** from the **Lock Enable** field.



4. Press  or , or the **Switch** soft key to select the desired type from the **Lock Type** field.

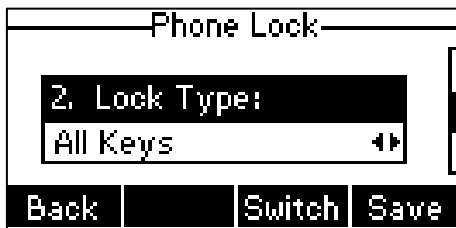

5. (Optional.) Enter the desired interval of automatic phone lock in the **Lock Time Out** field. The default timeout is 0. It means the phone will not be automatically locked. You need to long press  to lock it immediately when the phone is idle. If it is set to other values except 0 (e.g., 5), the phone will be locked when the phone is inactive in idle screen for the designated time (in seconds).
6. Press the **Save** soft key to accept the change.

When the phone is locked, the LCD screen prompts "Phone locked." and displays the icon .



**To change the phone unlock PIN via phone user interface:**

1. Press **Menu**->**Settings**->**Basic Settings**->**Change PIN**.
2. Enter the desired value in the **Old PIN**, **New PIN** and **Confirm PIN** field respectively.

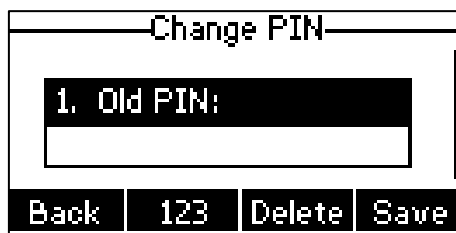

3. Press the **Save** soft key to accept the change or the **Back** soft key to cancel.

**Note** The unlock PIN length must be within 15 digits.

**To unlock the phone via phone user interface:**

1. Press any locked key, enter the "Phone Lock" screen.





2. Enter the desired PIN in the **Unlock PIN** field.
3. Press the **OK** soft key to unlock the phone.

The icon  disappears from the LCD screen.

You can long press  or wait for a period of time (if configured) to lock the phone again.

**Note** You can also unlock the phone by administrator password. When you enter the administrator password to unlock the phone, the phone will turn to the Change PIN screen.

**To deactivate the phone lock via phone user interface:**

1. Press **Menu->Settings->Basic Settings->Phone Lock**.
2. Enter the desired PIN (default PIN: 123) in the **Unlock PIN** field, and then press the **OK** soft key.
3. Press  or  , or the **Switch** soft key to select **Disabled** from the **Lock Enable** field.

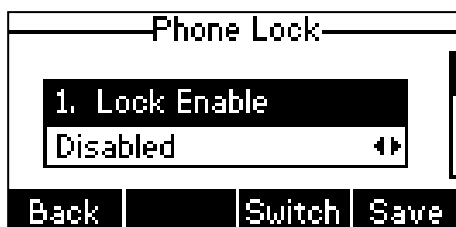

4. Press the **Save** soft key to accept the change.

Phone lock is configurable via web user interface at the path **Features->Phone Lock**.

## Audio Settings

### Volume

You can press the Volume key to adjust the ringer volume when the phone is idle or ringing. You can also press the Volume key to adjust the receiver volume of currently engaged audio devices (handset, speakerphone or headset) when the phone is in use.

**To adjust the ringer volume when the phone is idle:**

1. Press  to adjust the ringer volume.



**To adjust the ringer volume when the phone is ringing:**

1. Press  to adjust the ringer volume.

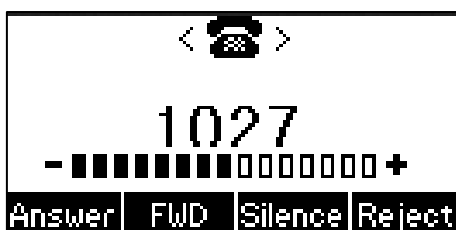



You can also press  to adjust the ringer volume when selecting a ring tone. For more information, refer to [Ring Tones](#) on page 29.

**Note**

If ringer volume is adjusted to minimum, the icon  will appear on the LCD screen.

**To adjust the volume when the phone is during a call:**



1. Press  to adjust the volume of currently engaged audio device (handset, speakerphone or headset).





## Ring Tones

Ring tones are used to indicate incoming calls. You can select different ring tones to distinguish your phone from your neighbor's.

**To select a ring tone for the phone via phone user interface:**

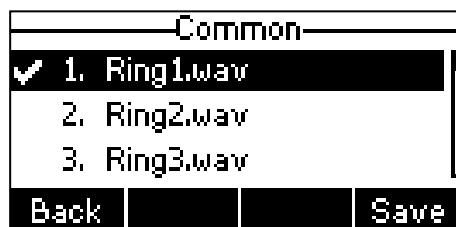

1. Press **Menu**->**Settings**->**Basic Settings**->**Sound**->**Ring Tones**->**Common**.
2. Press  or  to select the desired ring tone.





3. (Optional.) Press  to adjust the ringer volume.
4. Press the **Save** soft key to accept the change or the **Back** soft key to cancel.

A ring tone for the phone is configurable via web user interface at the path **Settings**->**Preference**->**Ring Type**.

**To select a ring tone for the account via phone user interface:**

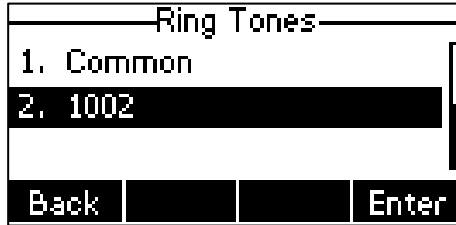
1. Press **Menu->Settings->Basic Settings->Sound->Ring Tones.**
2. Press  or  to select the desired account and then press the **Enter** soft key.



3. Press  or  to select the desired ring tone.  
If **Common** is selected, this account will use the ring tone selected for the phone.

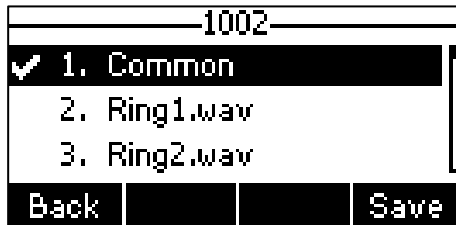

4. (Optional.) Press  to adjust the ringer volume.
5. Press the **Save** soft key to accept the change or the **Back** soft key to cancel.

A ring tone for the account is configurable via web user interface at the path **Account->Basic->Ring Type.**

**To upload a custom ring tone for your phone via web user interface:**

1. Click on **Settings->Preference.**
2. In the **Upload Ringtone** field, click **Browse** to locate a ring tone (the file format must be \*.wav) file from your local system.

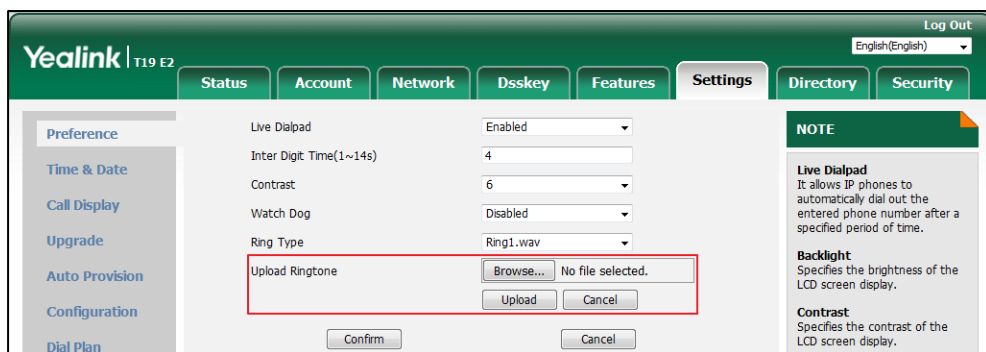

3. Click **Upload** to upload the file.  
The custom ring tone appears in the pull-down list of **Ring Type.**

You can only delete the custom ring tone by clicking **Del** when selecting the desired custom ring tone in the **Ring Type** field.

#### Note

The priority of ring tone for an incoming call on the phone is as follows:  
Contact ring tone (refer to [Adding Contacts](#)) >Group ring tone (refer to [Adding Groups](#)) >Account ring tone >Phone ring tone.



Both single custom ring tone file and total custom ring tone files must be within 100KB.

Uploading custom ring tones for your phone is configurable via web user interface only.

## Key Tone

If you enable key tone, the phone will produce a sound when you press the keypad.

**To configure key tone via phone user interface:**

1. Press **Menu->Settings->Basic Settings->Sound->Key Tone**.
2. Press  or , or the **Switch** soft key to select **Enabled** or **Disabled** from the **Key Tone** field.

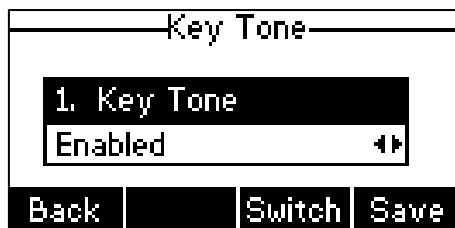

3. Press the **Save** soft key to accept the change or the **Back** soft key to cancel.

Key tone is configurable via web user interface at the path **Features->Audio**.

## Contact Management

This section provides the operating instructions for managing contacts. Topics include:





- [Directory](#)
- [Local Directory](#)
- [Blacklist](#)
- [Remote Phone Book](#)

## Directory

Directory provides easy access to frequently used lists. The lists may contain Local Directory, History, Remote Phone Book and LDAP. You can configure the list(s) to access for the **Dir** soft key.

**Note** LDAP is disabled by default. For more information, contact your system administrator.

### To configure the list(s) to access for the Dir soft key via web user interface:

1. Click on **Directory->Setting**.
2. In the **Directory** block, select the desired list from the **Disabled** column and then click  .  
The selected list appears in the **Enabled** column.
3. Repeat the step 2 to add more lists to the **Enabled** column.
4. To remove a list from the **Enabled** column, select the desired list and then click  .
5. To adjust the display order of enabled lists, select the desired list and then click  or  .

The LCD screen displays the list(s) in the adjusted order.

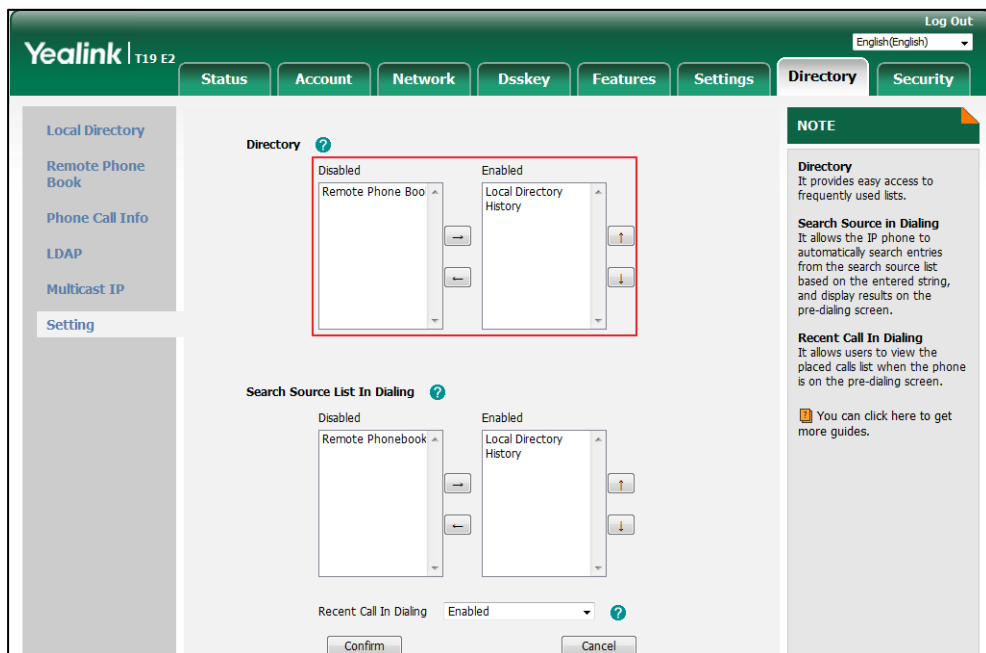

6. Click **Confirm** to accept the change.

**Note** The list(s) to access for the **Dir** soft key is configurable via web user interface only.

### To view the directory list(s) via phone user interface:

1. Press the **Dir** soft key when the phone is idle.

The LCD screen displays the enabled list(s) in the directory.



If there is only one list in the directory, press the **Dir** soft key to enter this list directly.

#### Note

If the remote phone book and LDAP are not configured in advance, you cannot see remote phone book and LDAP lists on the phone user interface. For more information on remote phone book, refer to [Remote Phone Book](#) on page 43. For more information on LDAP, contact your system administrator.

## Local Directory

The built-in phone directory can store the names and phone numbers of your contacts. You can store up to 1000 contacts and 48 groups in your phone's local directory. You can add new groups and contacts, edit, delete or search for a contact, or simply dial a contact number from the local directory.

#### Note

Local directory can be backed up on the provisioning server. For more information, contact your system administrator.

## Adding Groups

**To add a group to the local directory:**



1. Press the **Dir** soft key.

The IP phone enters the local directory directly as there is only Local Directory enabled in the directory by default.



If Local Directory is removed from the directory (refer to [Directory](#) on page 32), press **Menu->Directory->Local Directory** to enter the local directory.

2. Press the **AddGr** soft key.
3. Enter the desired group name in the **Name** field.

4. Press  or , or **Switch** soft key to select the desired group ring tone from the **Ring** field.

If **Auto** is selected, this group will use the ring tone according to the priority: Contact ring tone (refer to [Adding Contacts](#)) >Account ring tone (refer to [Ring Tones](#)) >Phone ring tone (refer to [Ring Tones](#)). If a specific ring tone is selected, this group will use the ring tone according to the priority: Contact ring tone (refer to [Adding Contacts](#)) >Group ring tone.



5. Press the **Add** soft key to accept the change or the **Back** soft key to cancel.

## Editing Groups

**To edit a group in the local directory:**

1. Press the **Dir** soft key.



The IP phone enters the local directory directly as there is only Local Directory enabled in the directory by default.



If Local Directory is removed from the directory (refer to [Directory](#) on page 32), press **Menu->Directory->Local Directory** to enter the local directory.

2. Select the desired group.
3. Press the **Option** soft key, and then select **Detail**.



4. Press  or  to scroll through the group information and then edit.

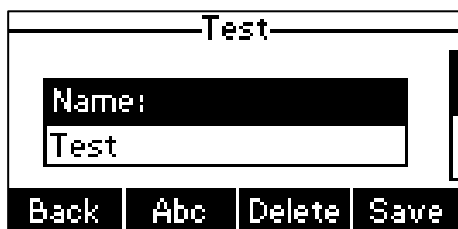

5. Press the **Save** soft key to accept change or the **Back** soft key to cancel.

## Deleting Groups

### To delete a group from the local directory:

1. Press the **Dir** soft key.

The IP phone enters the local directory directly as there is only Local Directory enabled in the directory by default.



If Local Directory is removed from the directory (refer to [Directory](#) on page 32), press **Menu->Directory->Local Directory** to enter the local directory.

2. Select the desired group.



3. Press the **Option** soft key, and then select **Delete**.

The LCD screen prompts the following warning:

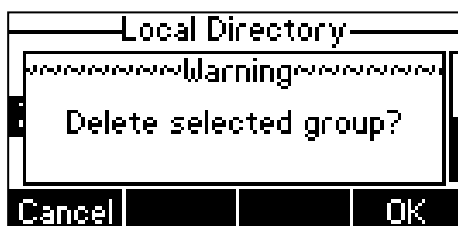

4. Press the **OK** soft key to confirm the deletion or the **Cancel** soft key to cancel.

You can also delete all groups by pressing the **Option** soft key and then select **Delete All**.

## Adding Contacts

You can add contacts to the local directory in the following ways:

- Manually
- From call history
- From a remote phone book

### Adding Contacts Manually

**To add a contact to the local directory manually:**

1. Press the **Dir** soft key.

The IP phone enters the local directory directly as there is only Local Directory enabled in the directory by default.



If Local Directory is removed from the directory (refer to [Directory](#) on page 32), press **Menu->Directory->Local Directory** to enter the local directory.

2. Select the desired contact group and then press the **Enter** soft key.

If the contact you want to add doesn't belong to any group, select **All Contacts** and then press the **Enter** soft key.

3. Press the **Add** soft key.
4. Enter the name and the office, mobile or other numbers in the corresponding fields.



5. Press  $\leftarrow$  or  $\rightarrow$ , or the **Switch** soft key to select the desired ring tone from the **Ring** field.

If **Auto** is selected, this contact will use the ring tone according to the priority: Group ring tone (refer to [Adding Groups](#)) > Account ring tone (refer to [Ring Tones](#)) > Phone ring tone (refer to [Ring Tones](#)).

6. Press  $\leftarrow$  or  $\rightarrow$ , or the **Switch** soft key to select the desired group from the **Group** field.



- Press the **Add** soft key to accept the change or the **Back** soft key to cancel.

**Note**

If the contact has existed in the directory, the LCD screen will prompt "Contact name existed!".

## Adding Contacts from Call History

### To add a contact to the local directory from the call history:

- Press the **History** soft key.
- Press  $\uparrow$  or  $\downarrow$  to highlight the desired entry.
- Press the **Option** soft key, and then select **Add to Contact**.



- Press the **OK** soft key, and then edit the contact name.
- Press the **Save** soft key to accept the change.  
The entry is successfully saved to the local directory.

## Adding Contacts from Remote Phone Book

### To add a contact to the local directory from remote phone book:

- Press **Menu->Directory->Remote Phone Book**.

If Remote Phone Book is added to the directory (refer to [Directory](#) on page 32), press **Dir->Remote Phone Book** to enter the remote phone book.

- Select the desired remote group and then press the **Enter** soft key.
- Press  $\uparrow$  or  $\downarrow$  to highlight the desired entry.
- Press the **Option** soft key, and then select **Add to Contact**.
- Press the **Save** soft key to save the contact in the local directory.

If the contact has already existed in the local directory, the LCD screen will prompt "Overwrite the original contact?". Press the **OK** soft key to overwrite the original contact in local directory or the **Cancel** soft key to cancel.

For more information on remote phone book operating, refer to [Remote Phone Book](#) on page 43.

## Editing Contacts

### To edit a contact in the local directory:

- Press the **Dir** soft key.

The IP phone enters the local directory directly as there is only Local Directory enabled in the directory by default.



If Local Directory is removed from the directory (refer to [Directory](#) on page 32), press **Menu->Directory->Local Directory** to enter the local directory.

2. Select the desired contact group and then press the **Enter** soft key.  
If the contact is not in any group, select **All Contacts** and then press the **Enter** soft key.
3. Press or to highlight the desired contact.
4. Press the **Option** soft key, and then select **Detail**.
5. Press or to highlight the contact information and then edit.



6. Press the **Save** soft key to accept change or the **Back** soft key to cancel.

## Deleting Contacts

**To delete a contact from the local directory:**

1. Press the **Dir** soft key.

The IP phone enters the local directory directly as there is only Local Directory enabled in the directory by default.



If Local Directory is removed from the directory (refer to [Directory](#) on page 32), press **Menu->Directory->Local Directory** to enter the local directory.

2. Select the desired contact group and then press the **Enter** soft key.  
If the contact is not in any group, select **All Contacts** and then press the **Enter** soft key.
3. Press or to highlight the desired contact.

4. Press the **Option** soft key, and then select **Delete**.

The LCD screen prompts the following warning:

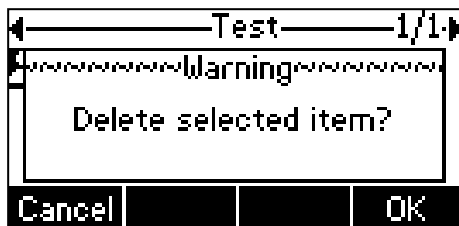

5. Press the **OK** soft key to confirm the deletion or the **Cancel** soft key to cancel.

You can also delete all contacts by pressing the **Option** soft key, and then select **Delete All**.

## Placing Calls to Contacts

**To place a call to a contact from the local directory:**

1. Press the **Dir** soft key.

The IP phone enters the local directory directly as there is only Local Directory enabled in the directory by default.



If Local Directory is removed from the directory (refer to [Directory](#) on page 32), press **Menu->Directory->Local Directory** to enter the local directory.

2. Select the desired contact group and then press the **Enter** soft key.  
If the contact is not in any group, select **All Contacts** and then press the **Enter** soft key.
3. Press  $\uparrow$  or  $\downarrow$  to highlight the desired contact.
4. Do one of the following:
  - If only one number of the contact is stored in the local directory, press the **Send** soft key to dial out the number.
  - If multiple numbers of the contact are stored in the local directory, press the **Send** soft key to display a list of numbers.  
Press  $\uparrow$  or  $\downarrow$  to highlight the desired number.  
Press the **Send** soft key to dial out the number.

## Searching for Contacts

**To search for a contact in the local directory:**

1. Press the **Dir** soft key.

The IP phone enters the local directory directly as there is only Local Directory enabled in the directory by default.



If Local Directory is removed from the directory (refer to [Directory](#) on page 32), press **Menu->Directory->Local Directory** to enter the local directory.

2. Press the **Search** soft key.
3. Enter a few continuous characters of the contact name or continuous numbers of the contact number (office, mobile or other number) using the keypad.



The contacts whose name or phone number matches the characters entered will appear on the LCD screen. You can dial from the result list.

## Importing/Exporting Contact Lists

You can manage your phone's local directory via phone user interface or web user interface. But you can only import or export the contact list via web user interface.

### To import an XML file of contact list via web user interface:

1. Click on **Directory->Local Directory**.
2. Click **Browse** to locate a contact list file (the file format must be \*.xml) from your local system.

- Click **Import XML** to import the contact list.

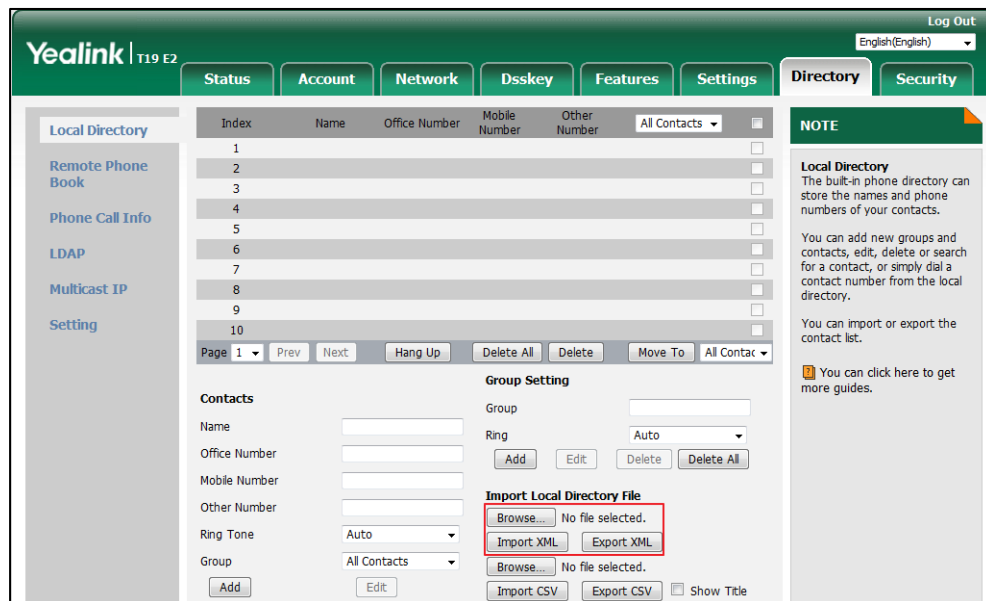

The web user interface prompts “The original contact will be covered, continue?”.

- Click **OK** to complete importing the contact list.

#### To import a CSV file of contact list via web user interface:

- Click on **Directory->Local Directory**.
- Click **Browse** to locate a contact list file (file format must be \*.csv) from your local system.
- (Optional.) Check the **Show Title** checkbox.

It will prevent importing the title of the contact information which is located in the first line of the CSV file.

- Click **Import CSV** to import the contact list.
- (Optional.) Mark the **On** radio box in the **Delete Old Contacts** field.

It will delete all existing contacts while importing the contact list.

- Select the contact information you want to import into the local directory from the pull-down list of **Index**.

At least one item should be selected to be imported into the local directory.

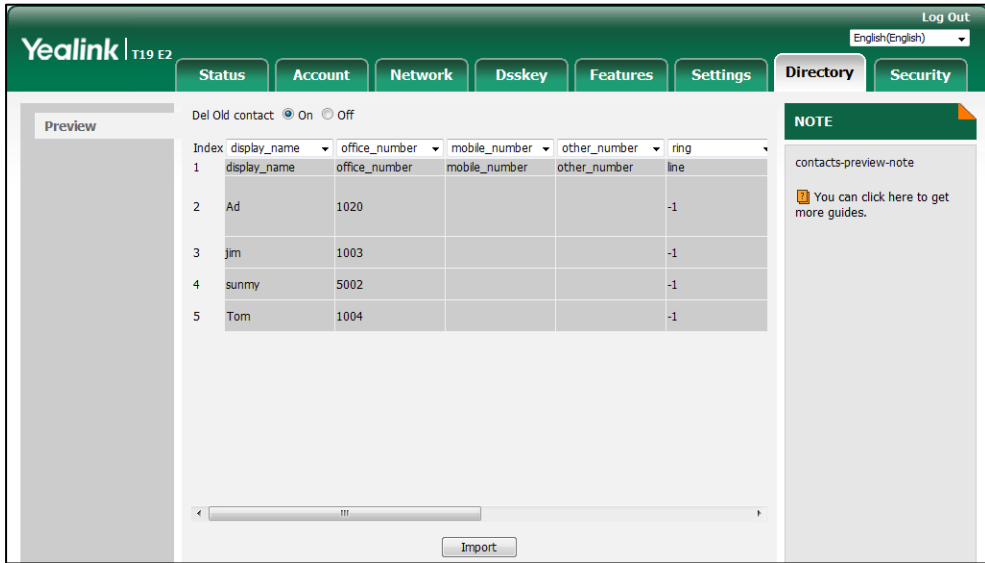

7. Click **Import** to complete importing the contact list.

**To export a contact list via web user interface:**

1. Click on **Directory->Local Directory**.
2. Click **Export XML** (or **Export CSV**).
3. Click **Save** to save the contact list to your local system.

**Note** Importing/exporting contact lists is available via web user interface only.

## Blacklist

The built-in phone directory can store names and phone numbers for a blacklist. You can store up to 30 contacts, add, edit, delete or search for a contact in the blacklist directory, and even call a contact from the blacklist directory. Incoming calls from blacklist directory contacts will be rejected automatically.

**To add a contact to the blacklist directory manually:**

1. Press **Menu->Directory->Blacklist**.
2. Press the **Add** soft key.
3. Enter the name and the office, mobile or other numbers in the corresponding fields.



4. Press the **Add** soft key to accept the change or the **Back** soft key to cancel.

**To add a contact to the blacklist directory from the local directory:**

1. Press the **Dir** soft key.

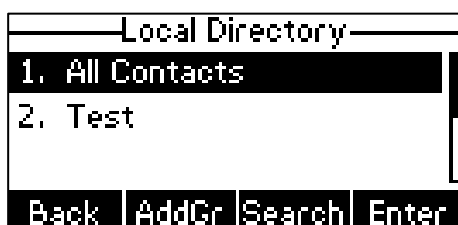

The IP phone enters the local directory directly as there is only Local Directory enabled in the directory by default.



If Local Directory is removed from the directory (refer to [Directory](#) on page 32), press **Menu->Directory->Local Directory** to enter the local directory.

2. Select the desired contact group and then press the **Enter** soft key.

If the contact is not in any group, select **All Contacts** and then press the **Enter** soft key.

3. Press  or  to highlight the desired contact.
4. Press the **Option** soft key and then select **Add to Blacklist**.

The LCD screen prompts the following warning:



5. Press the **OK** soft key to accept the change.

For operating instructions on editing, deleting, placing calls to and/or searching for contacts in the blacklist directory, refer to the operating instructions of [Editing Contacts](#) on page 37, [Deleting Contacts](#) on page 38, [Placing Calls to Contacts](#) on page 39 and/or [Searching for Contacts](#) on page 39.

## Remote Phone Book

You can add new contacts to the local directory, search for a contact, or simply dial a contact number from the remote phone book.

You can configure your new phone to access up to 5 remote phone books. For the access URL of the remote phone book, contact your system administrator.

For operating instructions on placing calls to and/or searching for contacts in the remote phone book, refer to the operating instructions of [Placing Calls to Contacts](#) on page 39 and/or [Searching for Contacts](#) on page 39.

## Configuring an Access URL

To configure an access URL for a remote phone book via web user interface:

1. Click on **Directory**->**Remote Phone Book**.
2. Enter the access URL in the **Remote URL** field.
3. Enter the name in the **Display Name** field.

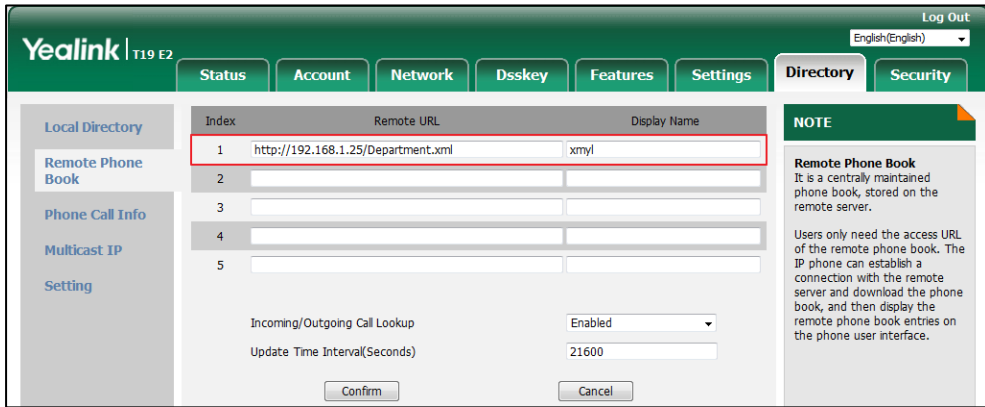

4. Click **Confirm** to accept the change.

### Note

An access URL for a remote phone book is configurable via web user interface only.

## Accessing the Remote Phone Book

To access your remote phone book via phone user interface:

1. Press **Menu**->**Directory**->**Remote Phone Book**.  
If Remote Phone Book is added to the directory (refer to [Directory](#) on page 32), press **Dir**->**Remote Phone Book** to enter the remote phone book.
2. Press  $\uparrow$  or  $\downarrow$  to select the desired remote group, and then press the **Enter** soft key.  
The phone then connects to the remote phone book and proceeds to load it. The contacts in the remote phone book are displayed on the LCD screen.

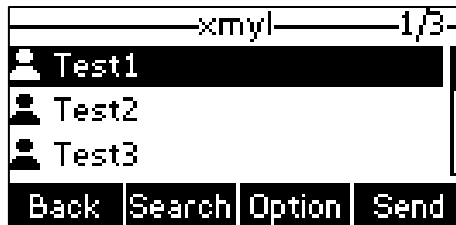

3. Press the **Back** soft key to back to the previous screen.

### Note

An access URL for a remote phone book is configurable via web user interface only.  
The size of a remote phone book file should be less than 750k.



## Incoming/Outgoing Call Lookup

You can enable the phone to present the caller/callee identity stored in the remote phone book when receiving/placing a call.

**To configure incoming/outgoing call lookup and update time interval via web user interface:**

1. Click on **Directory**->**Remote Phone Book**.
2. Select **Enabled** from the pull-down list of **Incoming/Outgoing Call Lookup**.
3. Enter the desired refresh period in the **Update Time Interval(Seconds)** field.

The default value is 21600.

Index	Remote URL	Display Name
1	http://192.168.1.25/Department.xml	xmyl
2		
3		
4		
5		

Incoming/Outgoing Call Lookup: Enabled

Update Time Interval(Seconds): 21600

NOTE: Remote Phone Book. It is a centrally maintained phone book, stored on the remote server. Users only need the access URL of the remote phone book. The IP phone can establish a connection with the remote server and download the phone book, and then display the remote phone book entries on the phone user interface.

4. Click **Confirm** to accept the change.

## Call History Management

The SIP-T19(P) E2 IP phone maintains call history lists of Placed Calls, Received Calls, Missed Calls and Forwarded Calls. Each call history list supports up to 100 entries. You can view call history, place a call, add a contact or delete an entry from the call history list.

History record feature is enabled by default. If you don't want to save the call history, you can disable the feature.

## Viewing History Records





**To view the call history:**

1. Press the **History** soft key.  
The LCD screen displays all call records.
2. Press **◀** or **▶** to switch among **All Calls**, **Missed Calls**, **Placed Calls**, **Received Calls** and **Forwarded Calls**.
3. Press **▲** or **▼** to select the desired entry.
4. Press the **Option** soft key, and then select **Detail**.

The detailed information of the entry appears on the LCD screen.





## Placing a Call from History Records

**To place a call from the call history list:**

1. Press the **History** soft key.
2. Press  or  to switch among **All Calls**, **Missed Calls**, **Placed Calls**, **Received Calls** and **Forwarded Calls**.
3. Press  or  to select the desired entry.
4. Press the **Send** soft key.

## Adding a Contact to the Local Directory/Blacklist





**To add a contact to the local directory (or blacklist directory) from the call history list:**

1. Press the **History** soft key.
2. Press  or  to switch among **All Calls**, **Missed Calls**, **Placed Calls**, **Received Calls** and **Forwarded Calls**.
3. Press  or  to select the desired entry.
4. Press the **Option** soft key, and then select **Add to Contact** (or **Add to Blacklist**).
5. Enter the desired values in the corresponding fields.
6. Press the **Save** soft key.



For more information on local directory and/or blacklist, refer to [Local Directory](#) on page 33 and/or [Blacklist](#) on page 42.

## Deleting History Records

**To delete an entry from the call history list:**

1. Press the **History** soft key.
2. Press  or  to switch among **All Calls**, **Missed Calls**, **Placed Calls**, **Received Calls** and **Forwarded Calls**.
3. Press  or  to select the desired entry.
4. Press the **Delete** soft key.

**To delete all entries from the call history list:**

1. Press the **History** soft key.
2. Press  or  to switch among **All Calls**, **Missed Calls**, **Placed Calls**, **Received Calls** and **Forwarded Calls**.
3. Press the **Option** soft key, and then select **Delete All**.

4. Press the **OK** soft key.

The LCD screen prompts "Delete all the call records?".

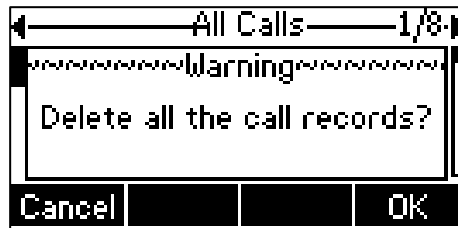

5. Press the **OK** soft key to confirm the deletion or the **Cancel** soft key to cancel.

## Disabling History Record

**To disable history record via phone user interface:**

1. Press **Menu->Features->History Setting**.
2. Press  $\leftarrow$  or  $\rightarrow$ , or the **Switch** soft key to select **Disabled** from the **History Record** field.

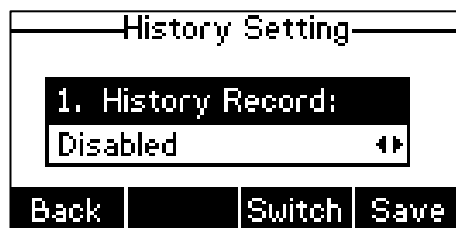

3. Press the **Save** soft key to accept the change or the **Back** soft key to cancel.

## Search Source List in Dialing



You can search for a contact from the desired lists when the phone is on the dialing screen. The lists can be Local Directory, History, Remote Phone Book and LDAP.

### Note

LDAP is disabled by default. For more information, contact your system administrator.

**To configure search source list in dialing via web user interface:**

1. Click on **Directory->Setting**.
2. In the **Search Source List In Dialing** block, select the desired list from the **Disabled** column and then click  $\rightarrow$ .  
The selected list appears in the **Enabled** column.
3. Repeat the step 2 to add more lists to the **Enabled** column.
4. To remove a list from the **Enabled** column, select the desired list and then click  $\leftarrow$ .

- To adjust the display order of search results, select the desired list and then click  or  .

The LCD screen will display search results in the adjusted order.

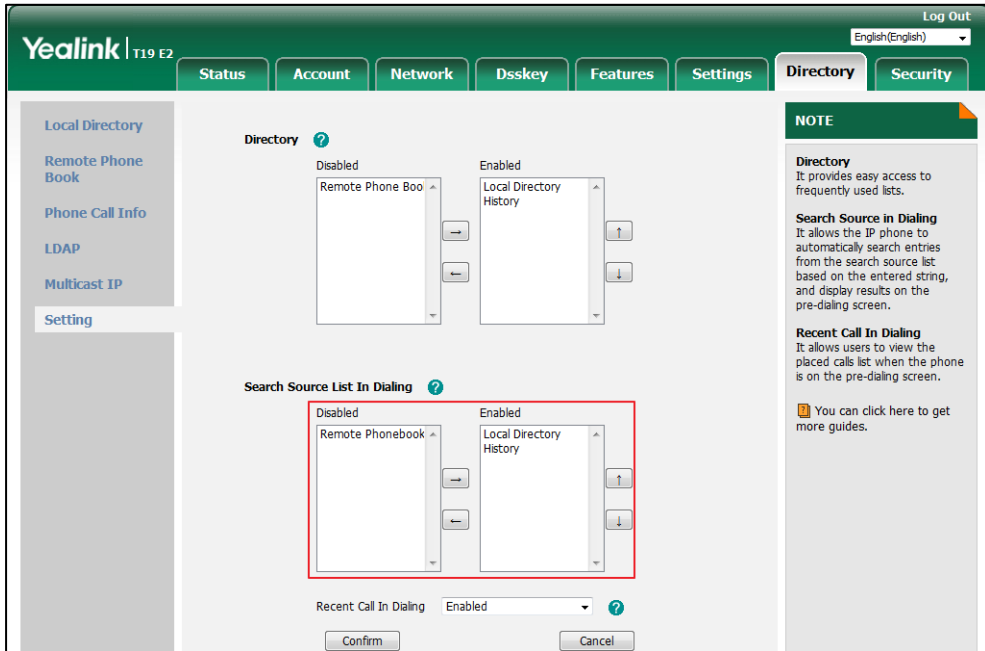



- Click **Confirm** to accept the change.

**Note** Search source list in dialing is configurable via web user interface only.

**To search for a contact in the enabled search source lists:**

- Pick up the handset or press the Speakerphone key.
- Enter a few continuous characters of the entry's name or continuous numbers of the entry's phone number (office, mobile or other number) using the keypad.

The entries in the enabled search source lists whose name or phone number matches the characters entered will appear on the LCD screen. You can press  or  to scroll to the desired entry, and then place a call to the entry.

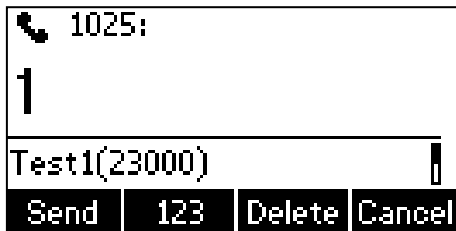

## System Customizations

### Logo Customization

You can upload your custom logo which will be shown on the idle screen.

**To upload a custom logo via web user interface:**

1. Click on **Features->General Information**.
2. Select **Custom logo** from the pull-down list of **Use Logo**.
3. Click **Browse** to locate the logo file from your local system.

The screenshot shows the Yealink T19 E2 web interface. The 'Features' tab is selected, and the 'General Information' sub-tab is active. The 'Use Logo' dropdown menu is set to 'Custom logo'. The 'Upload Logo' section is highlighted with a red box, showing a 'Browse...' button and 'No file selected.' text. Other settings visible include 'Call Waiting' (Enabled), 'Call Waiting On Code', 'Call Waiting Off Code', 'Auto Redial' (Disabled), 'Call Number Filter', 'Reboot in Talking' (Disabled), 'Hide Feature Access Codes' (Disabled), and 'Display Method on Dialing' (User Name). A 'NOTE' section on the right provides details for 'Call Waiting', 'Auto Redial', 'Key As Send', 'Hotline', and 'Call Completion'.

4. Click **Upload** to upload the file.

#### Note

**Delete** item will appear after you upload a custom logo, you can click **Delete** to delete the custom logo.

The logo file format must be \*.dob, contact your system administrator for more information.

A custom logo can be uploaded via web user interface only.

### Headset Use



If you want to use a headset, physically connect your headset and activate the headset mode for use. For more information on physically connecting a headset, refer to [Phone Installation](#) on page 11.

#### Note



To use headset, make sure the headset mode is enabled. Contact your system administrator for more information.

## Headset Mode Activation/Deactivation

### To activate the headset mode:

1. Press  on the phone.  
The headset icon  appears on the idle screen.  
Press the **Answer** soft key to answer an incoming call. The call will be connected to your headset automatically.  
Enter the desired number and then press the **Send** soft key, the phone will then place a call using the headset automatically. For more information on using the headset to place a call, refer to [Placing Calls](#) on page 65.

### To deactivate the headset mode:

1. Press  again on the phone.  
The headset icon  disappears from the idle screen.

## Headset Prior

You can use headset in priority when headset prior feature is enabled. This feature is especially useful for permanent or full-time headset users.

### To enable headset prior via web user interface:

1. Click on **Features->General Information**.
2. Select **Enabled** from the pull-down list of **Headset Prior**.

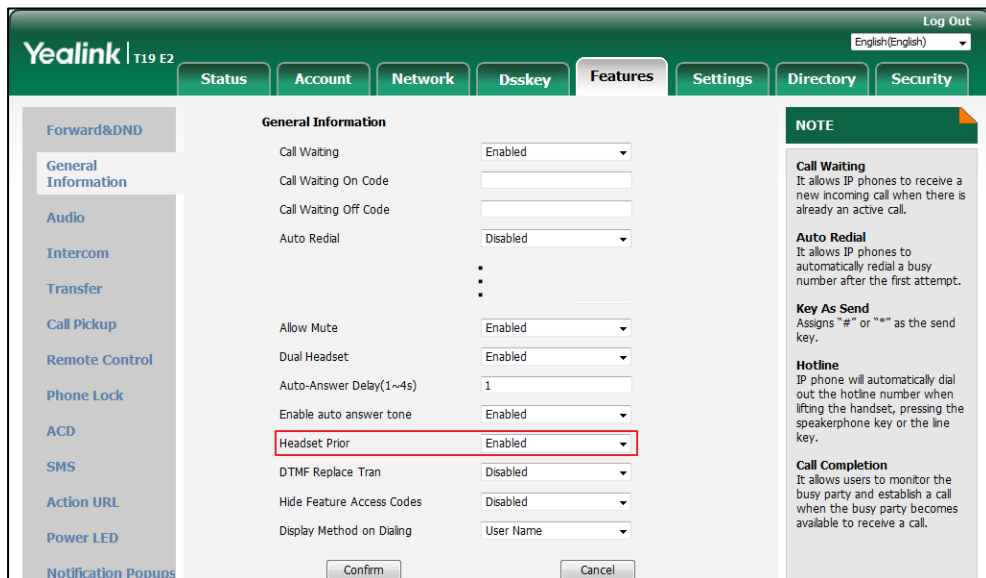

3. Click **Confirm** to accept the change.

**To use headset prior feature, you should activate the headset mode in advance:**

1. Physically connect the headset.
2. Press  to activate the headset mode.

**Note**

If headset prior is enabled, the headset mode will not be deactivated until you press the **Headset** key again.

If headset prior is disabled, the headset mode can be deactivated by pressing the Speakerphone key or the **Headset** key.

Headset prior is configurable via web user interface only.

## Dual Headset

You can use two headsets when enabling dual headset. To use this feature, you must physically connect headsets to the headset jack and handset jack respectively. Once the phone connects to a call, the headset connected to the headset jack will have full-duplex capabilities, while the one connected to the handset jack will only be able to listen.

**To enable dual headset via web user interface:**

1. Click on **Features->General Information**.
2. Select **Enabled** from the pull-down list of **Dual Headset**.

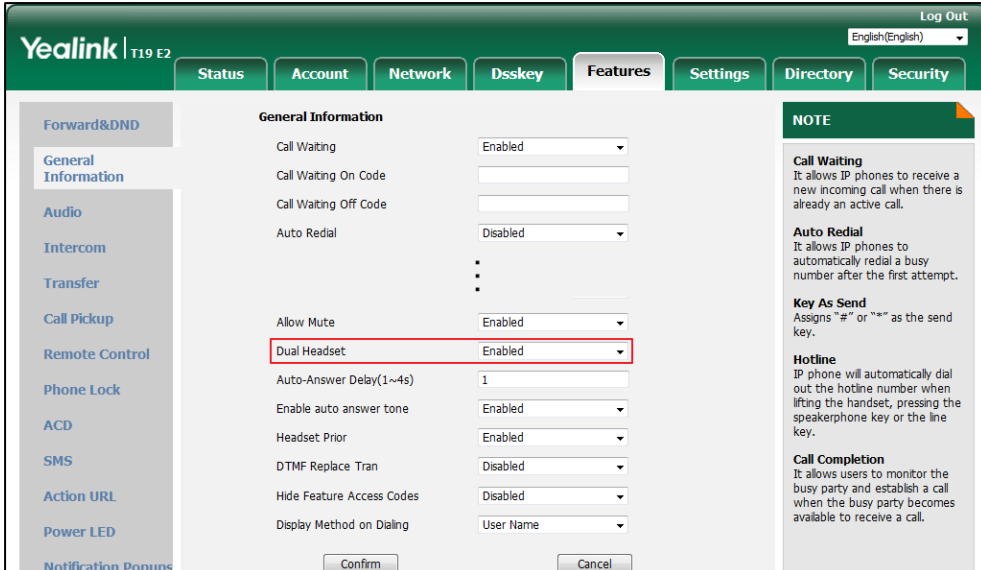

The screenshot shows the Yealink T19 E2 web user interface. The 'Features' tab is selected, and the 'General Information' section is active. The 'Dual Headset' option is highlighted with a red box and is set to 'Enabled'. Other settings include Call Waiting (Enabled), Auto Redial (Disabled), Allow Mute (Enabled), Auto-Answer Delay (1), Enable auto answer tone (Enabled), Headset Prior (Enabled), DTMF Replace Tran (Disabled), Hide Feature Access Codes (Disabled), and Display Method on Dialing (User Name). A 'NOTE' section on the right provides details for Call Waiting, Auto Redial, Key As Send, Hotline, and Call Completion.

3. Click **Confirm** to accept the change.

**Note**

Dual headset is configurable via web user interface only.

## Programable Keys

You can customize the soft keys, navigation keys and function keys. The SIP-T19(P) E2 IP phone

supports 11 programmable keys.

**To customize soft keys via phone user interface:**

1. Press **Menu**->**Settings**->**Advanced Settings** (default password: admin) ->**Softkey Label**.
2. Select the desired soft key, and then press the **Enter** soft key.
3. Select the desired key type from the **Type** field.



4. (Optional.) Enter the string that will appear on the LCD screen in the **Label** field.
5. (Optional.) Enter the corresponding value in the **Value** field.
6. Press the **Save** soft key to accept the change or the **Back** soft key to cancel.

**To customize the programmable keys via web user interface:**

1. Click on **Dsskey**->**Programmable Key**.
2. Customize specific features for these keys.

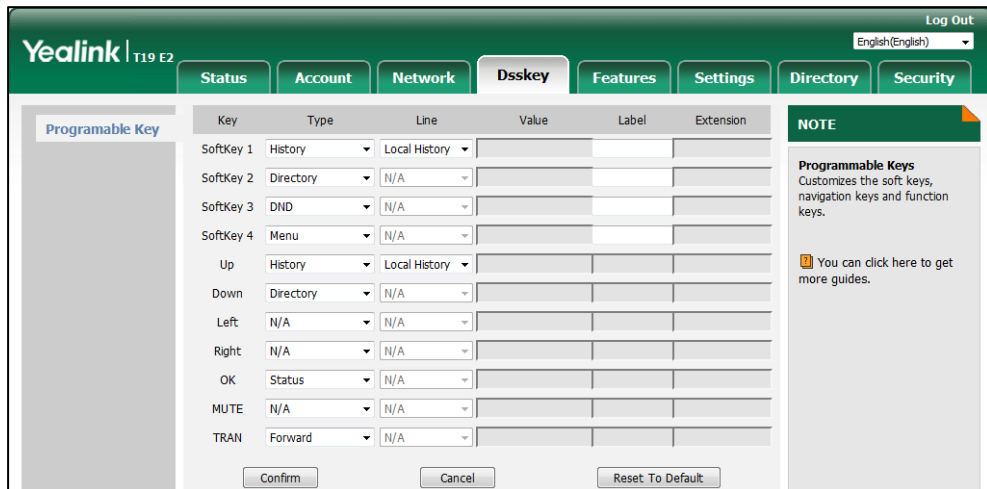

3. (Optional.) Enter the string that will appear on the LCD screen in the **Label** field.  
Label is configurable only when customizing SoftKey (1-4).
4. Click **Confirm** to accept the change.

You can click **Reset To Default** to reset custom settings to defaults.

**Note**

Navigation keys and function keys are configurable via web user interface only.  
The Mute key cannot be customized when keep mute feature is enabled. For more information, contact your system administrator.



Common used programable key features are explained in the following subchapters in detail:

- Speed Dial
- Direct Pickup
- Group Pickup
- Prefix
- Local Directory
- Local Group
- XML Directory
- XML Group
- XML Browser
- LDAP
- SMS
- New SMS
- Zero Touch
- Phone Lock
- Directory

For the features not listed above, refer to [Basic Call Features](#) on page 65 and [Advanced Phone Features](#) on page 99. For more information, contact your system administrator.

### Speed Dial

You can use this key feature to speed up dialing numbers frequently used or hard to remember.

**Dependencies:** *Type (SpeedDial)*

*Value* (the number you want to dial out)

*Label* (key label displayed on the LCD screen)

**Usage:** Press the **Speed Dial** key to dial out the number specified in the **Value** field.

### Direct Pickup

You can use this key feature to answer someone else's incoming call on the phone.

**Dependencies:** *Type (Direct Pickup)*

*Value* (the directed call pickup code followed by the specific phone number)

*Label* (key label displayed on the LCD screen)

**Usage:** Press the **Direct Pickup** key on your phone when the target phone number receives an incoming call. The call is then answered on your phone.

### Group Pickup

You can use this key feature to answer incoming calls in a group that is associated with their own group.

**Dependencies: Type (Group Pickup)**

*Value (the group call pickup code)*

*Label (key label displayed on the LCD screen)*

**Usage:** Press the **Group Pickup** key on your phone when a phone number in the group receives an incoming call. The call is answered on your phone.

**Prefix**

You can use this key feature to add a specified prefix number before the dialed number. You can only configure the SoftKey (1-4) as a Prefix key.

**Dependencies: Type (Prefix)**

*Value (the prefix number)*

*Label (key label displayed on the LCD screen)*

**Usage:** Press the **Prefix** key when the phone is idle, then the phone will enter into the dialing screen and display the prefix number which you specified in the **Value** field. You can enter remaining digits and then dial out.

**Local Directory**

You can use this key feature to access the local directory quickly. For more information, refer to [Local Directory](#) on page 33.

**Dependencies: Type (Local Directory)**

*Label (key label displayed on the LCD screen)*

**Usage:** Press the **Local Directory** key to access the local directory quickly.

**Local Group**

You can use this key feature to access the group in the local directory quickly. For more information, refer to [Local Directory](#) on page 33.

**Dependencies: Type (Local Group)**

*Line (the contact group you want to access)*

*Label (key label displayed on the LCD screen)*

**Usage:** Press the **Local Group** key to access the contact group specified in the **Line** field.

**XML Directory**

You can use this key feature to access the corporate directory quickly. For more information, refer to [Remote Phone Book](#) on page 43.

**Dependencies: Type (XML Directory)**

*Label (key label displayed on the LCD screen)*

**Usage:** Press the **XML Directory** key to access the corporate directory quickly.

**XML Group**

You can use this key feature to access the remote group in your remote phone book quickly.

You should configure remote phone book in advance. For more information, refer to [Remote Phone Book](#) on page 43.

**Dependencies:** *Type (XML Group)*

*Line* (the remote group you want to access if the remote phone book is configured)

*Label* (key label displayed on the LCD screen)

**Usage:** Press the **XML Group** key to access the remote group specified in the **Line** field.

### XML Browser

You can use this key feature to access an XML browser quickly. The XML browser allows you to create custom services which meet your functional requirements on the server. You can customize practical applications, such as weather report, stock information, Google search, etc.

**Dependencies:** *Type (XML Browser)*

*Value* (the access URL for xml browser)

*Label* (key label displayed on the LCD screen)

**Usage:** Press the **XML Browser** key to access the XML browser specified in the **Value** field.

### LDAP

You can use this key feature to quickly access a LDAP search screen.

**Dependencies:** *Type (Key Event)*

*Key Type (LDAP)*

*Label* (key label displayed on the LCD screen)

**Usage:**

1. Press the **LDAP** key to access the LDAP search screen.
2. Enter a few continuous characters of the contact name or continuous numbers of the contact number using the keypad.

The contacts whose name or phone number matches the characters entered will appear on the LCD screen.

**Note**

LDAP is disabled by default. For more information, contact your system administrator.

### SMS

You can use this key feature to quick access text message. For more information, refer to [Short Message Service \(SMS\)](#) on page 120.

**Dependencies:** *Type (SMS)*

*Label* (key label displayed on the LCD screen)

**Usage:** Press the **SMS** key when the phone is idle to access the text message.

### **New SMS**

You can use this key feature to quick access the new text message. For more information, refer to [Short Message Service \(SMS\)](#) on page 120.

**Dependencies:** *Type (New SMS)*

*Label (key label displayed on the LCD screen)*

**Usage:** Press the **New SMS** key when the phone is idle to access the New Message screen. You can enter the text message and then send it.

### **Zero Touch**

You can use this key feature to configure auto provision and network parameters quickly.

**Dependencies:** *Type (Zero Touch)*

*Label (key label displayed on the LCD screen)*

**Usage:**

1. Press the **Zero Touch** key to access the zero touch screen.
2. Press the **OK** soft key in a few seconds.
3. Configure the network parameters in the corresponding fields.
4. Press the **Next** soft key.
5. Configure the auto provision parameters in the corresponding fields.
6. Press the **OK** soft key.

The phone will reboot to update configurations.

### **Phone Lock**

You can use this key feature to immediately lock your phone instead of long pressing . For more information, refer to [Phone Lock](#) on page 25.

**Dependencies:** *Type (Key Event)*

*Key Type (Phone Lock)*

*Label (key label displayed on the LCD screen)*

**Usage:** When the phone lock feature is enabled, press the **Phone Lock** key to immediately lock your phone instead of long pressing .

### **Directory**

You can use this key feature to easily access frequently used lists. For more information, refer to [Directory](#) on page 32.

**Dependencies:** *Type (Directory)*



*Label (key label displayed on the LCD screen)*

**Usage:** Press the **Directory** key to immediately access frequently used lists.



## Account Registration

You can only register one account on the SIP-T19(P) E2 IP phone.

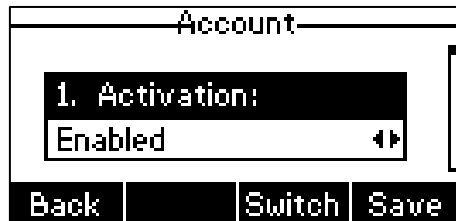

### To register an account via phone user interface:

1. Press **Menu**->**Settings**->**Advanced Settings** (default password: admin) ->**Accounts**.
2. Press the **Enter** soft key.
3. Press  or , or the **Switch** soft key to select **Enabled** from the **Activation** field.



4. Enter the desired value in **Label**, **Display Name**, **Register Name**, **User Name**, **Password** and **SIP Server1/2** field respectively. Contact your system administrator for more information.
5. If you use the outbound proxy servers, do the following:
  - 1) Press  or , or the **Switch** soft key to select **Enabled** from the **Outbound Status** field.
  - 2) Enter the desired value in the **Outbound Proxy1/2** and **Fallback Interval** field respectively. Contact your system administrator for more information.
6. Press the **Save** soft key to accept the change or the **Back** soft key to cancel.

### To disable an account via phone user interface:

1. Press **Menu**->**Settings**->**Advanced Settings** (default password: admin) ->**Accounts**.
2. Press  or , or the **Switch** soft key to select **Disabled** from the **Activation** field.
3. Press the **Save** soft key to accept the change or the **Back** soft key to cancel.

Account registration is configurable via web user interface at the path **Account**->**Register**.

## Dial Plan

Dial plan is a string of characters that governs the way your SIP-T19(P) E2 IP phone processes the inputs received from your phone keypad.

The SIP-T19(P) E2 IP phone supports the following dial plan features:

- [Replace Rule](#)
- [Dial Now](#)
- [Area Code](#)
- [Block Out](#)

The basic expression syntax you need to know:

.	The dot "." can be used as a placeholder or multiple placeholders for any character. Example: "12." would match "123", "1234", "12345", "12abc", etc.
x	An "x" can be used as a placeholder for any character. Example: "12x" would match "121", "122", "123", "12a", etc.
-	Numeric ranges are allowed within the brackets: Digit "-" Digit. Example: "[5-7]" would match the number "5", "6" or "7".
[]	The square brackets "[]" can be used as a placeholder for a single character which matches any of a set of characters. Example: "91[5-7]1234" would match "9151234", "9161234", "9171234".
()	The parentheses "()" can be used to group together patterns, for instance, to logically combine two or more patterns. Example: "([1-9])([2-7])3" would match "923", "153", "773", etc.
\$	The "\$" should be followed by the sequence number of a parenthesis. The "\$" plus the sequence number means the whole character or characters placed in the parenthesis. The number directs to the right parenthesis when there are more than one. Example: A replace rule configuration, Prefix: "001(xxx)45(xx)", Replace: "9001\$145\$2". When you dial out "0012354599" on your phone, the IP phone will replace the number with "9001 <b>235</b> 45 <b>99</b> ". "\$1" means 3 digits in the first parenthesis, that is, "235". "\$2" means 2 digits in the second parenthesis, that is, "99".

**Note**

The IP phone supports a new dial plan mechanism - digit map. Digit maps are defined by a single string or a list of strings. If a number you dial matches any string of a digit map, the call is automatically placed.  
Note that if digit map feature is enabled, the old dial plan rules (described in this chapter) will be ignored. For more information, contact your system administrator.

## Replace Rule

You can configure one or more replace rules (up to 100) to remove the specified string and replace it with another string. You can configure a pattern with wildcards (refer to the expression syntax in the table above), so that any string that matches the pattern will be replaced. This feature is convenient for you to dial out a long number. For example, a replace rule is configured as "Prefix: 1" and "Replace: 1234". When trying to dial out the number "1234", you just need to enter "1" on the phone and then press the **Send** soft key.

**To add a replace rule via web user interface:**

1. Click on **Settings->Dial Plan->Replace Rule**.
2. Enter the string (e.g., 1) in the **Prefix** field.

- Enter the string (e.g., 1234) in the **Replace** field.

- Click **Add** to add the replace rule.

When you enter the number "1" using the keypad and then press the **Send** soft key, the phone will dial out "1234" instead.

#### To edit a replace rule via web user interface:

- Click on **Settings->Dial Plan->Replace Rule**.
- Select the desired replace rule by checking the check box.
- Edit the values in the **Prefix** and **Replace** fields.
- Click **Edit** to accept the change.

#### To delete one or more replace rules via web user interface:

- Click on **Settings->Dial Plan->Replace Rule**.
- Select one or more replace rules by checking the check box(es).
- Click **Del** to delete the replace rule(s).

#### Note

Replace rule is configurable via web user interface only.

## Dial Now

You can configure one or more dial now rules (up to 100) on your phone. When the dialed number matches the dial now string, the number will be dialed out automatically. For example, a dial now rule is configured as "1xx", any entered three-digit string beginning with 1 will then be dialed out automatically on the phone.

#### To add a dial now rule via web user interface:

- Click on **Settings->Dial Plan->Dial Now**.

2. Enter the desired value (e.g., 1xx) in the **Rule** field.

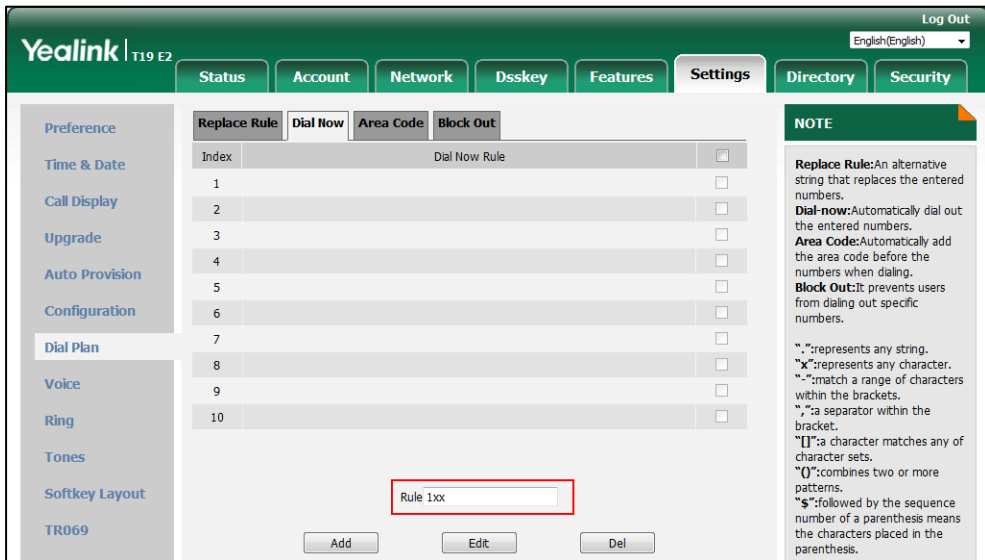

3. Click **Add** to add the dial now rule.

When you enter the number “123” using the keypad, the phone will dial out “123” automatically without pressing any key.

**Note**

You can also edit or delete the dial now rule, refer to [Replace Rule](#) on page 58 for more information.

Dial now rule is configurable via web user interface only.

**Time Out for Dial Now Rule**

You can configure the delay time for dial now rules. That is, you can configure your phone to automatically dial out the phone number which matches a dial now rule, after the designated delay time.

**To configure the time out for dial now rule via web user interface:**

1. Click on **Features->General Information**.
2. Enter the time between 0 and 14 (seconds) in the **Time Out for Dial Now Rule** field.



The default value is "1".

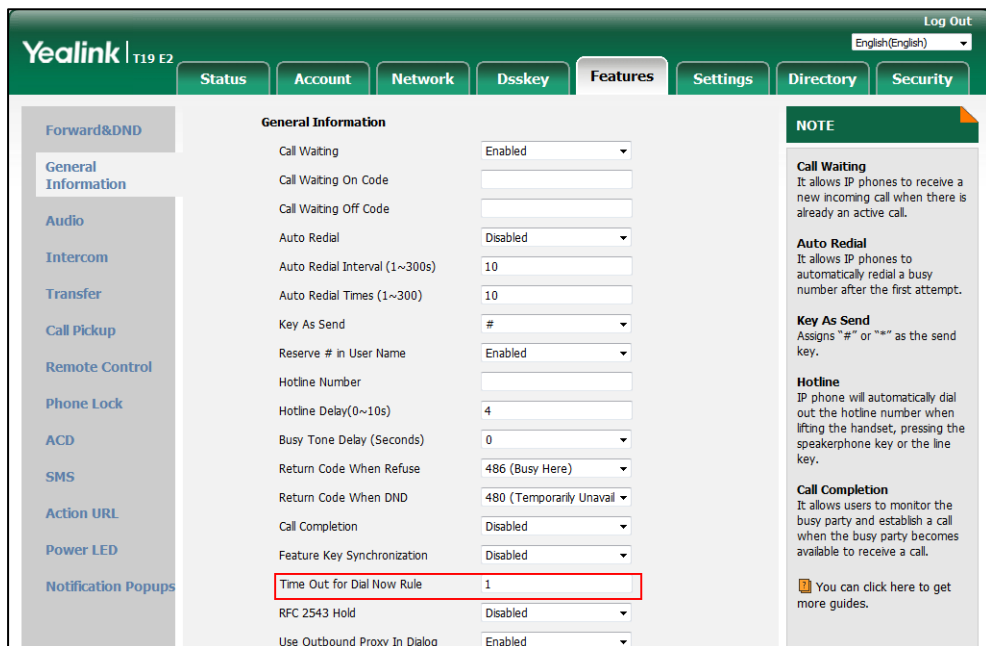

3. Click **Confirm** to accept the change.

**Note** Time out for dial now rule is configurable via web user interface only.

## Area Code

Area codes are also known as Numbering Plan Areas (NPAs). They usually indicate geographical areas in a country. This feature is necessary when dialing a phone number outside the code area. For example, an area code is configured as "Code: 0592, Min Length: 1, Max Length: 15". When you dial out the number "56789" (the length of the number is between 1 and 15), the phone will add the area code and dial out the number "059256789". You can only configure one area code rule on your phone.

### To configure the area code via web user interface:

1. Click on **Settings->Dial Plan->Area Code**.
2. Enter the desired values in the **Code**, **Min Length (1-15)** and **Max Length (1-15)** fields.

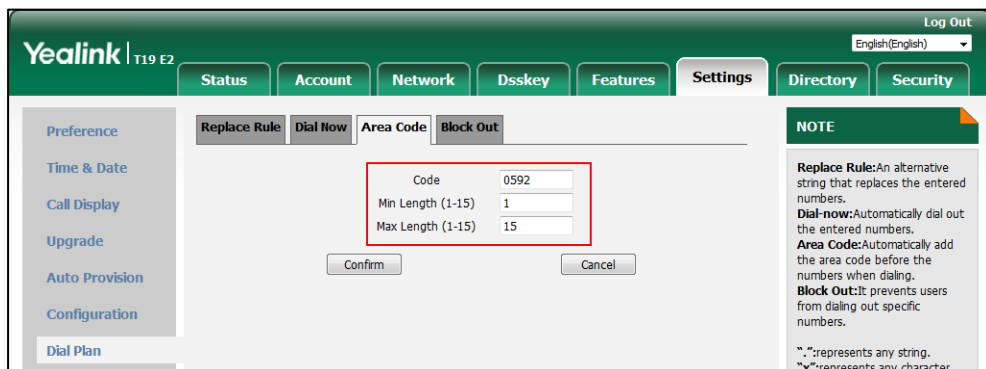

3. Click **Confirm** to accept the change.

**Note**

The default value of minimum and maximum length is 1 and 15 respectively.  
Area code is configurable via web user interface only.

## Block Out

You can block some specific numbers (up to 10) from being dialed on your phone. When you dial a block out number on your phone, the dialing will fail and the LCD screen will prompt "Forbidden Number".

**To add a block out number via web user interface:**

1. Click on **Settings->Dial Plan->Block Out**.
2. Enter the desired value in the **BlockOut NumberX** field.

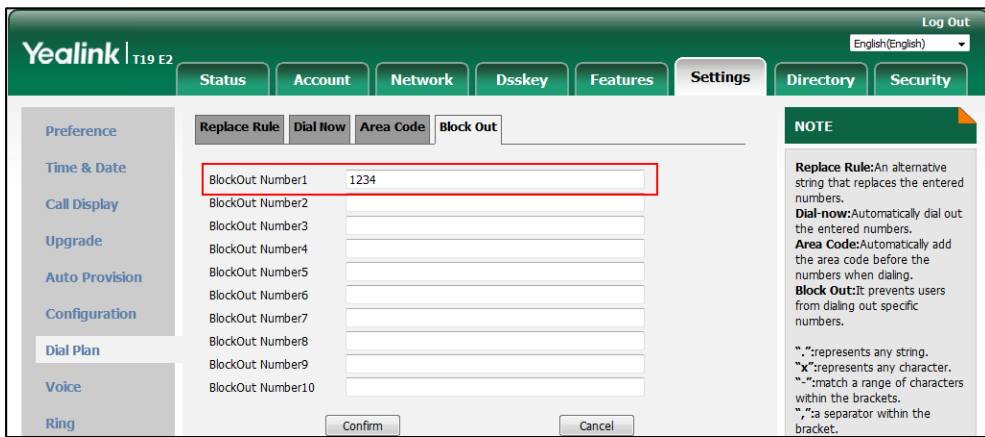

3. Click **Confirm** to add the block out number.

**Note**

Block out number is configurable via web user interface only.

## Emergency Number

Public telephone networks in countries around the world have a single emergency telephone number (emergency services number), that allows a caller to contact local emergency services for assistance when necessary. The emergency telephone number may differ from country to country. It is typically a three-digit number so that it can be easily remembered and dialed quickly. Some countries have a different emergency number for each of the different emergency services.

You can specify the emergency telephone numbers on the IP phone for contacting the emergency services in an emergency situation. You can dial these numbers when the phone is locked. For more information on phone lock, refer to [Phone Lock](#) on page 25.

**Note**

Contact your local phone service provider for available emergency numbers in your area.

The IP phone also supports the emergency dialplan, which allows users to make emergency calls if the phone is locked or unregistered. For more information, contact your system administrator.

**To specify emergency numbers via web user interface:**

1. Click on **Features->Phone Lock**.
2. Enter the emergency number in the **Emergency** field.

For multiple emergency numbers, enter a comma between every two emergency numbers. The default emergency numbers are 112, 911 and 110.

The screenshot shows the Yealink T19 E2 web interface. The 'Features' tab is selected, and the 'Phone Lock' sub-tab is active. The 'Emergency' field is highlighted with a red border and contains the text '112,911,110'. Below the form are 'Confirm' and 'Cancel' buttons. On the right, a 'NOTE' panel provides information about the phone lock feature.

3. Click **Confirm** to accept the change.

**Note**

Emergency number is configurable via web user interface only.

## Live Dialpad

You can enable live dialpad feature on the SIP-T19(P) E2 IP phone, which enables the IP phone to automatically dial out a phone number without pressing the send key. You can also configure a delay, and then the phone will dial out the phone number automatically after the designated period of time.

**To enable live dialpad via web user interface:**

1. Click on **Settings->Preference**.
2. Select **Enabled** from the pull-down list of **Live Dialpad**.
3. Enter the desired delay time in the **Inter Digit Time(1~14s)** field.

The default delay time is 4 seconds.

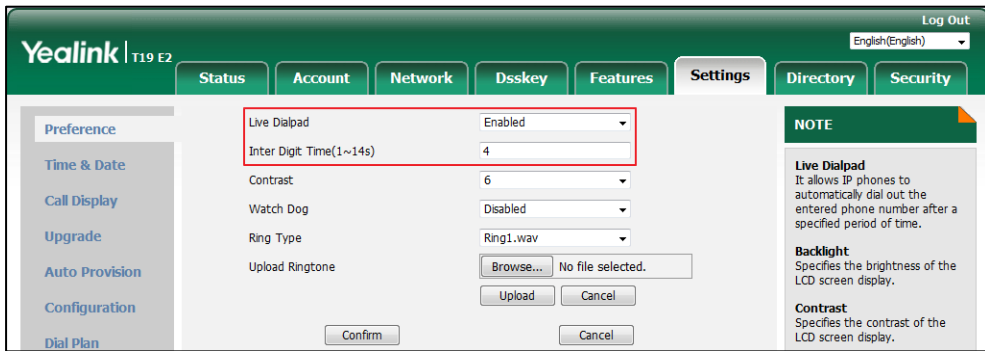

4. Click **Confirm** to accept the change.

**Note** Live dialpad is configurable via web user interface only.

## Hotline

You can dial a hotline number immediately upon lifting the handset or pressing the Speakerphone key. You can also configure a delay, and then the phone will dial out the hotline number automatically after the designated period of time.

### To configure the hot line number via phone user interface:

1. Press **Menu->Features->Hot Line**.
2. Enter the desired number in the **Hotline Number** field.

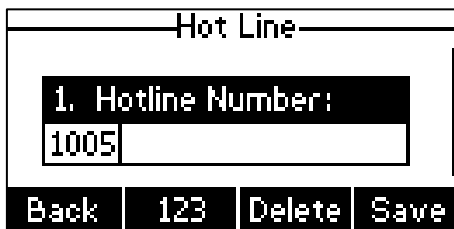

3. Enter the delay time in the **Hotline Delay** field.  
The valid values range from 0 to 10 (seconds) and the default value is "4".
4. Press the **Save** soft key to accept the change or the **Back** soft key to cancel.

Hotline is configurable via web user interface at the path **Features->General Information**.

## Basic Call Features

---

The SIP-T19(P) E2 IP phone is designed to be easily used like a regular phone on a public switched telephone network (PSTN). You can place calls, answer calls, transfer a call to someone else, or conduct a conference call.

This chapter provides basic operating instructions for the SIP-T19(P) E2 IP phone. Topics include:

- [Placing Calls](#)
- [Answering Calls](#)
- [Ending Calls](#)
- [Redialing Numbers](#)
- [Recent Call In Dialing](#)
- [Auto Answer](#)
- [Auto Redial](#)
- [Call Completion](#)
- [ReCall](#)
- [Call Mute](#)
- [Call Hold/Resume](#)
- [Do Not Disturb \(DND\)](#)
- [Call Forward](#)
- [Call Transfer](#)
- [Call Waiting](#)
- [Conference](#)
- [Call Park/Retrieve](#)
- [Call Pickup](#)
- [Anonymous Call](#)
- [Anonymous Call Rejection](#)

If you require additional information or assistance with your new phone, contact your system administrator.

## Placing Calls

You can place a call in one of three ways using your SIP-T19(P) E2 IP phone:

- Using the handset

- Using the speakerphone
- Using the headset

You can also dial the number first, and then choose the way you want to speak to the other party.



You can also search and dial a contact from call history, local directory or remote phone book. For more information, refer to [Contact Management](#) on page 31 and [Call History Management](#) on page 45.

During a call, you can alternate between Speakerphone, Headset and Handset modes by pressing the Speakerphone key, the Headset key, or by picking up the handset.

The call duration of the active call and far-site's information (name or phone number) are visible on the LCD screen. In the figure below, the call to "Tom" (the phone number: 1002) has lasted 34 seconds.



**To place a call using the handset:**

1. Pick up the handset.
2. Enter the desired number using the keypad.
3. Press  ,  , or the **Send** soft key.

The # key is configured as a send key by default. You can also set the \* key as the send key, or set neither. For more information, refer to [Key As Send](#) on page 25.







**Note**

You can also dial using the SIP URI or IP address. To obtain the IP address of a phone, press the  key when the phone is idle. The maximum SIP URI or IP address length is 32 characters. For example, SIP URI: 2210@sip.com, IP: 192.168.1.15 (192\*168\*1\*15).



Your phone may not support direct IP dialing. Contact your system administrator for more information.

**To place a call using the hands-free (speakerphone) mode:**

Do one of the following:

- With the handset on-hook, press  to obtain a dial tone.  
Enter the desired number using the keypad.  
Press  ,  , or the **Send** soft key.
- With the handset on-hook, enter the desired number using the keypad.  
Press  ,  ,  , or the **Send** soft key.

**To place a call using the headset:**

1. With the optional headset connected, press  to activate the headset mode.
2. Enter the desired number using the keypad.
3. Press , , or the **Send** soft key.



**Note**



To permanently use the headset mode, refer to [Headset Prior](#) on page 50.

The SIP-T19(P) E2 IP phone can handle multiple calls at a time. However, only one active call (the call that has audio associated with it) can be in progress at any time, other calls are placed on hold. The SIP-T19(P) E2 IP phone can handle a maximum of 2 calls at one time.

**To place multiple calls:**

You can have more than one call on your SIP-T19(P) E2 IP phone. To place a new call during an active call:

1. Press the **Hold** soft key to place the original call on hold.
2. Press the **NewCall** soft key.
3. Enter the desired number using the keypad.
4. Press , , or the **Send** soft key.

You can press  or  to switch between the calls, and then press the **Resume** soft key to retrieve the desired call.

**Note**

If you want to place more than 2 calls at one time, the IP phone LCD screen will prompt "Sorry, you can only make two calls!".

## Answering Calls

When you are not in another call, you can answer a call in one of three ways:

- Using the handset
- Using the speakerphone
- Using the headset

**Note**

You can reject incoming calls by pressing the **Reject** soft key. You can also activate Do Not Disturb mode to ignore all incoming calls without ring on your phone. For more information, refer to [Do Not Disturb \(DND\)](#) on page 76.

You can forward incoming calls to someone else by pressing the **FWD** soft key. For more information, refer to [Call Forward](#) on page 78.

**Answering When Not in Another Call**

Call duration and destination will always appear on the LCD screen for the active call.

**To answer a call using the handset:**

1. Pick up the handset.

**To answer a call using the hands-free (speakerphone) mode:**

Do one of the following:

- Press  .
- With the handset on-hook and the headset mode deactivated, press the **Answer** soft key.



**To answer a call using the headset:**

Do one of the following:

- Press  .
- With the headset mode activated, press the **Answer** soft key.

**Answering When in Another Call**

If you have an active call, and an incoming call arrives on the phone, do one of the following:

- Press the **Answer** soft key.  
The incoming call is answered and the original call is placed on hold.
- Press  to access the new call.  
Press  or the **Answer** soft key.  
The incoming call is answered and the original call is placed on hold.

## Ending Calls

**To end a call:**

Do one of the following:

- If you are using the handset, press the **EndCall** soft key or hang up the handset.
- If you are using the headset, press the **EndCall** soft key.
- If you are using the speakerphone, press  or the **EndCall** soft key.

## Redialing Numbers



**To redial the last dialed number from your phone:**

1. Press  twice.  
A call to your last dialed number is attempted.

**To redial a previously dialed number from your phone:**

1. Press  when the phone is idle.



- Press  or  to select the desired entry from the placed calls list, and then press  or the **Send** soft key.

## Recent Call In Dialing

To view the placed calls list when the phone is on the dialing screen, you should enable recent call in dialing in advance.

**To enable recent call in dialing via web user interface:**

- Click on **Directory**->**Setting**.
- Select **Enabled** from the pull-down list of **Recent Call In Dialing**.

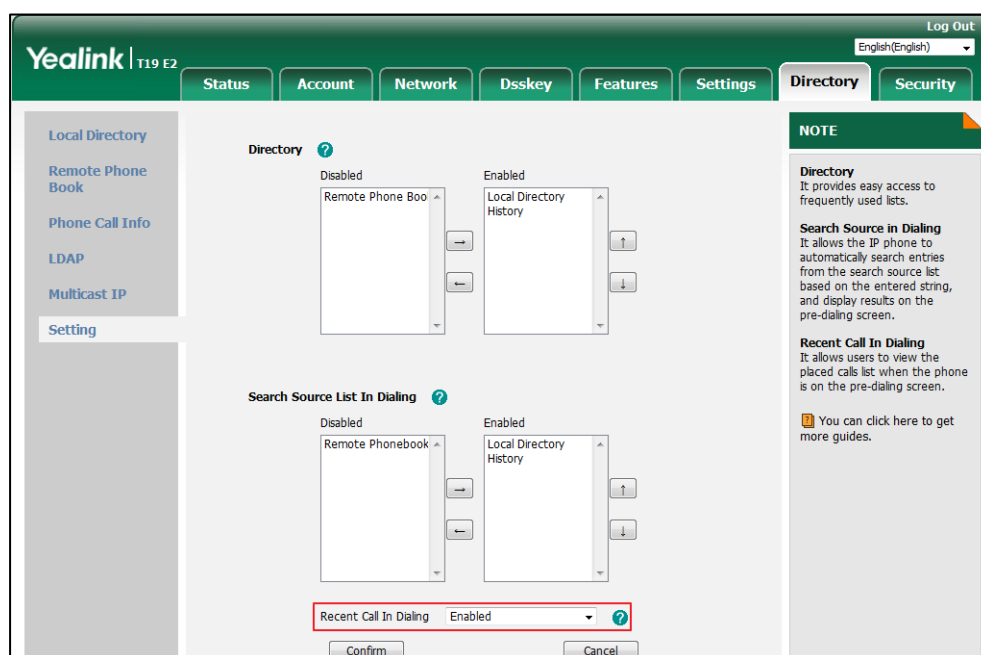

- Click **Confirm** to accept the change.

**Note** Recent call in dialing is configurable via web user interface only.

**To view placed calls list when the phone is on the dialing screen:**

- Pick up the handset or press the Speakerphone key.  
The LCD screen displays the placed calls list.

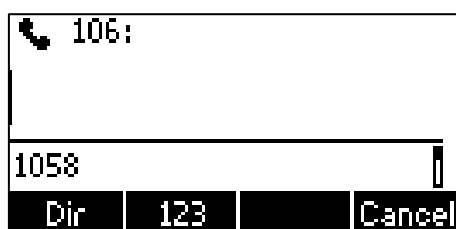

You can also enter a few continuous characters of the contact name or continuous numbers of the contact number (office, mobile or other number) to search from placed calls list.

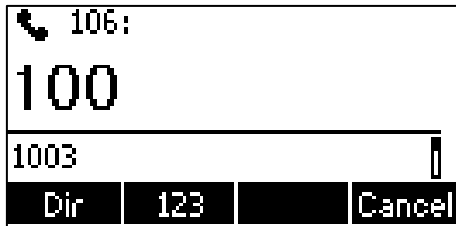

## Auto Answer

You can use auto answer feature to automatically answer an incoming call.

You can choose to mute the local microphone when an incoming call is answered automatically.

For more information, refer to [Keep Mute](#) on page 74.

### To configure auto answer via phone user interface:

1. Press **Menu**->**Features**->**Auto Answer**.
2. Press  to select the **Status**, and the press  or , or the **Switch** soft key to select **Enabled** from the **Status** field.

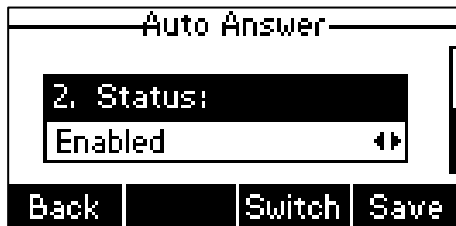

3. Press the **Save** soft key to accept the change or the **Back** soft key to cancel.

The icon  appears on the LCD screen.

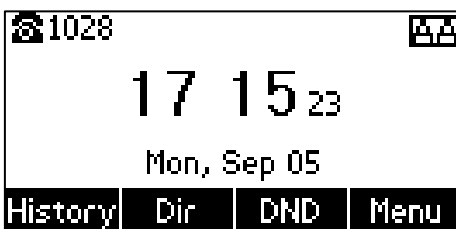

Auto answer is configurable via web user interface at the path **Account**->**Basic**.



### Note

Auto answer only takes effect when there is no other call in progress on the phone. If there is a call in progress, the second incoming call cannot be automatically answered after ending the current call by default. If you want to make the phone automatically answer the incoming call after ending all calls, contact your system administrator for more information.

## Auto Redial

You can enable auto redial to automatically redial a phone number when the called party is busy. You can also configure the number of auto redial attempts and the time to wait between redial attempts.

### To configure auto redial via phone user interface:

1. Press **Menu->Features->Auto Redial**.
2. Press  or , or the **Switch** soft key to select **Enabled** from the **Auto Redial** field.



3. Enter the desired time (in seconds) in the **Redial Interval** field.  
The default value is "10".
4. Enter the desired number of redial attempts in the **Redial Times** field.  
The default value is "10".
5. Press the **Save** soft key to accept the change or the **Back** soft key to cancel.

Auto redial is configurable via web user interface at the path **Features->General Information**.

### To use auto redial:

When the called party is busy, the following prompt will appear on the LCD screen of the phone:



1. Press the **OK** soft key to activate auto redial. The following prompt will appear on the LCD screen of the phone:

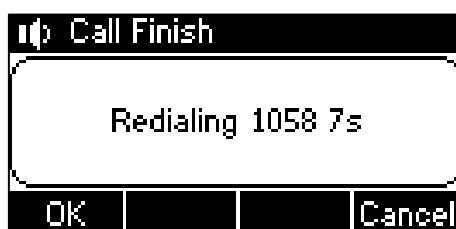

2. Wait for the designated period of time or press the **OK** soft key to redial the phone

number.

The phone will retry as many times as configured until the called party is idle.

## Call Completion

You can use call completion to notify the caller who failed to reach a desired party when the party becomes available to receive a call.

### To configure call completion via phone user interface:

1. Press **Menu->Features->Call Completion**.
2. Press **◀** or **▶**, or the **Switch** soft key to select **Enabled** from the **Call Completion** field.

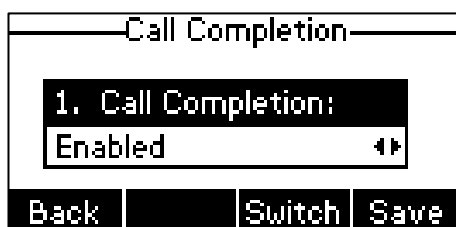

3. Press the **Save** soft key to accept the change or the **Back** soft key to cancel.

Call completion is configurable via web user interface at the path **Features->General Information**.

### To use call completion:

When the called party is busy, the following prompt will appear on the LCD screen of the phone:

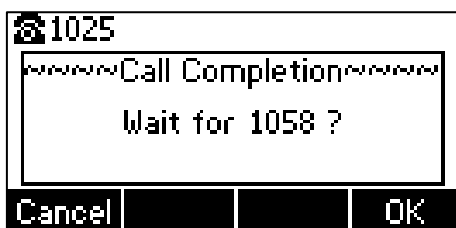

1. Press the **OK** soft key, the phone returns to the idle screen and call completion is activated.

When the called party becomes idle, the following prompt will appear on the LCD screen of the phone:

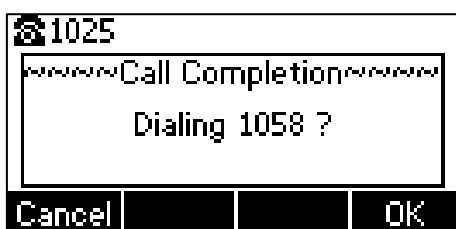

1. Press the **OK** soft key to redial the number.

**Note**

Call completion is not available on all servers. For more information, contact your system administrator.

## ReCall

You can press a recall key to place a call back to the last incoming call.

### To configure a recall key via web user interface:

1. Click on **Dsskey->Programmable Key**.
2. Select the desired programable key.
3. Select **ReCall** from the pull-down list of **Type**.
4. (Optional.) Enter the string that will appear on the LCD screen in the **Label** field.  
Label is configurable only when customizing SoftKey (1-4).

Key	Type	Line	Value	Label	Extension
SoftKey 1	History	Local History			
SoftKey 2	Directory	N/A			
SoftKey 3	DND	N/A			
SoftKey 4	ReCall	N/A			
Up	History	Local History			
Down	Directory	N/A			
Left	N/A	N/A			
Right	N/A	N/A			
OK	Status	N/A			
Mute	N/A	N/A			
Tran	Forward	N/A			

**NOTE**  
**Programmable Keys**  
 Customizes the soft keys, navigation keys and function keys.  
 You can click here to get more guides.

5. Click **Confirm** to accept the change.

**Note**

A recall key is configurable via web user interface only.

## Call Mute

You can mute the microphone of the active audio device during an active call so that the other party cannot hear you. You can also mute the microphone while dialing so that the other party cannot hear you when the call is set up. It helps prevent the other party from hearing the informal discussion when auto answer is enabled on his/her phone.

Call mute applies to all modes (Handset, Headset and Speakerphone).

## Keep Mute

Normally, the mute feature is deactivated when the active call ends. Keep mute feature enables you to make the mute state of your phone persist across calls. This feature should be pre-configured by your system administrator. When keep mute is enabled and you press the MUTE key, the phone stays in the mute state until you un-mute the microphone or until the phone restarts. It helps prevent the other party from hearing the noise coming from your room when auto answer is enabled on your phone. When you mute the phone in an idle state or any other states, the mute key LED illuminates solid red and the icon  appears on the status bar.

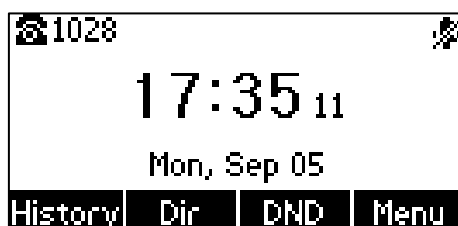

## Muting a Call

### To mute a call:

1. Press  during an active call.

The LCD screen indicates that the call is now muted.



### To un-mute a call:

1. Press  again to un-mute the call.

## Muting While Dialing

### To mute the microphone while dialing:

1. Press  on the pre-dialing, dialing or calling screen.

The call is muted automatically when setting up successfully.



**To un-mute the microphone while dialing:**

1. Press  again to un-mute the call.

**Note**

You can also mute the microphone when the IP phone is ringing.

## Call Hold/Resume

You can place an active call on hold. Only one active call can be in progress at any time. Other calls can be made and received while placing the original call on hold. When you place a call on hold, your IP PBX may play music to the other party while waiting.

**To place a call on hold:**

1. Press the **Hold** soft key during a call.

The LCD screen indicates that the call is on hold.



**Note**



The phone will beep softly every 30 seconds to remind you that you still have a call on hold. The phone ignores engaged audio device (handset or headset) and switches to Speakerphone to play the hold tone by default.

**To resume a held call:**

1. Press the **Resume** soft key.

**Multiple Calls on Hold:**

If multiple calls are placed on hold:

1. Press  or  to switch between the calls, and then press the **Resume** soft key to retrieve the desired call.

If more than one call is placed on hold, a numbered prompt appears on the LCD screen, for example "1/2", indicating that this is the first call out of two calls.

## Do Not Disturb (DND)

You can use DND to reject incoming calls automatically on the phone. The prompt message "**n New Missed Call(s)**" ("n" indicates the number of missed calls, e.g., 1 New Missed Call(s)) will appear on the LCD screen, and callers will receive a busy message. All calls you receive while DND is activated are logged to your missed calls list.



### Note

The prompt message will display only if Missed Call Log is enabled. Missed call log is configurable via web user interface at the path **Account->Basic**.

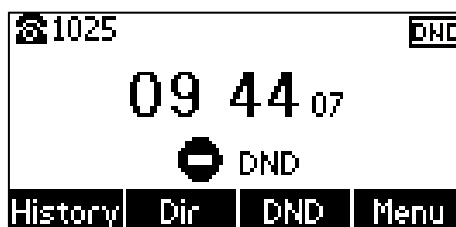

You cannot activate or deactivate DND when DND feature is disabled. Contact your system administrator for more information.

When DND feature is activated, the IP phone supports displaying a large DND icon on the idle screen. For more information, contact your system administrator.



### To activate DND via phone user interface:

Do one of the following:

- Press the **DND** soft key when the phone is idle if DND on code and off code are not needed on the server.
- Press **Menu->Features->DND**.  
Press  or , or the **Switch** soft key to select **Enabled** from the **DND Status** field. (Optional.) Enter the DND on code or off code respectively in the **On Code** or **Off Code** field.

If the on code or off code is configured, the IP phone will send the corresponding code to activate or deactivate DND on the server. It is not available on all servers.

Press the **Save** soft key to accept the change.



The icon  will appear on the status bar.

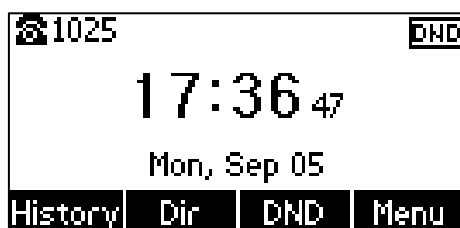

#### Note

When DND and busy forward are activated at the same time, calls will be sent to the configured destination number. For more information on busy forward, refer to [Call Forward](#) on page 78.

You can receive incoming calls from authorized numbers when DND is activated.

#### To configure the DND authorized numbers via web user interface:

1. Click on **Features->Forward&DND**.
2. Select **Enabled** from the pull-down list of **DND Emergency**.
3. Enter the numbers in the **DND Authorized Numbers** field.  
For multiple numbers, enter a comma between every two numbers.

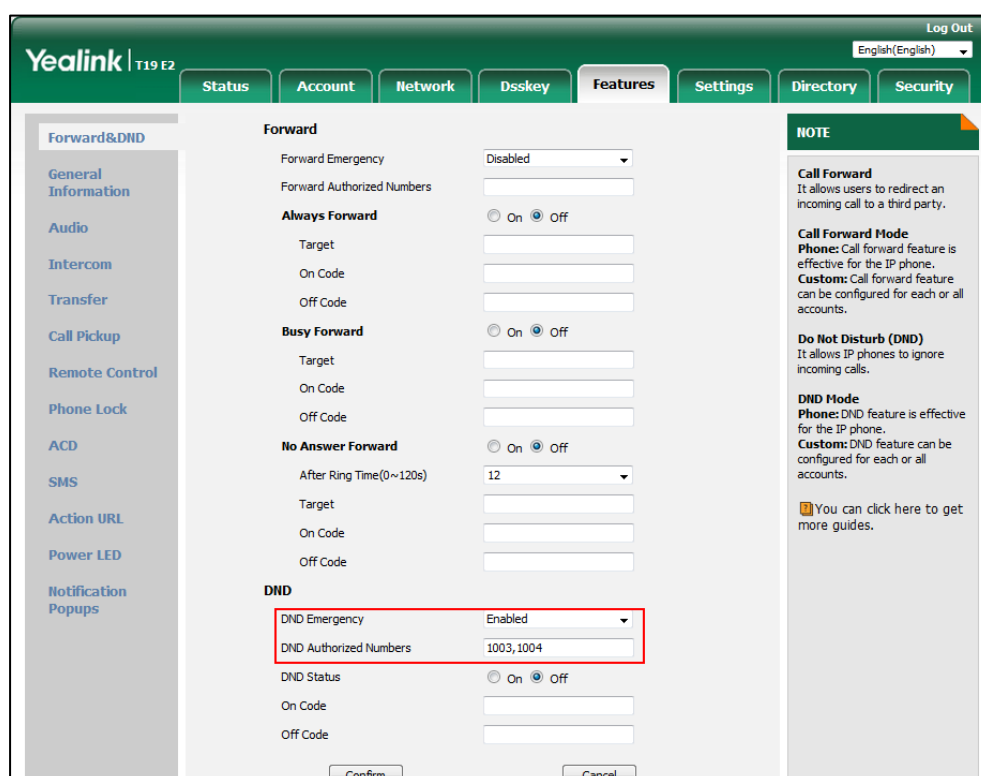

4. Click **Confirm** to accept the change.

When DND is activated on the phone, the phone can still receive incoming calls from the numbers specified in the **DND Authorized Numbers** field.

**Note**

DND authorized number is configurable via web user interface only.

When the phone misses a call, a prompt window will pop up by default. If you want to disable the feature, contact your system administrator for more information.

**To deactivate DND via phone user interface:**

1. Press the **DND** soft key when the phone is idle.

## Call Forward

You can configure your phone to forward incoming calls to another party (static forwarding).

You can also forward calls while your phone is ringing (dynamic forwarding).

**Note**

When the phone forwards a call, a prompt window will pop up by default. If you want to disable the feature, contact your system administrator for more information.



You cannot activate or deactivate call forward when call forward feature is disabled. Contact your system administrator for more information.

## Static Forwarding

Three types of static forwarding:

- **Always Forward:** Incoming calls are immediately forwarded.
- **Busy Forward:** Incoming calls are immediately forwarded if the phone is busy.
- **No Answer Forward:** Incoming calls are forwarded if not answered after a period of time.

**To activate call forward via phone user interface:**

1. Press **Menu->Features->Call Forward**.
2. Press  or  to select the desired forwarding type, and then press the **Enter** soft key.
3. Depending on your selection:
  - a) If you select **Always Forward**:

- 1) Press  $\leftarrow$  or  $\rightarrow$ , or the **Switch** soft key to select **Enabled** from the **Always Forward** field.

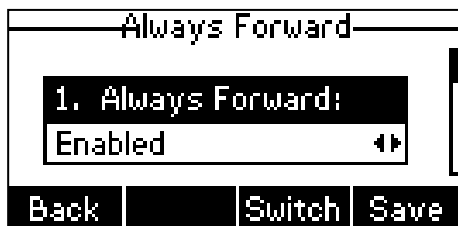

- 2) Enter the destination number you want to forward all incoming calls to in the **Forward to** field.
- 3) (Optional.) Enter the always forward on code or off code respectively in the **On Code** or **Off Code** field.

b) If you select **Busy Forward**:

- 1) Press  $\leftarrow$  or  $\rightarrow$ , or the **Switch** soft key to select **Enabled** from the **Busy Forward** field.

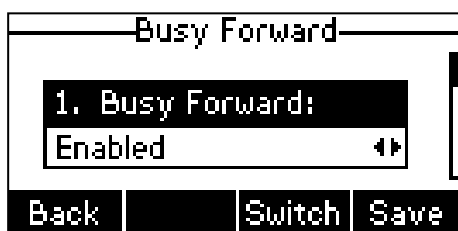

- 2) Enter the destination number you want to forward incoming calls to when the phone is busy in the **Forward to** field.
- 3) (Optional.) Enter the busy forward on code or off code respectively in the **On Code** or **Off Code** field.

c) If you select **No Answer Forward**:

- 1) Press  $\leftarrow$  or  $\rightarrow$ , or the **Switch** soft key to select **Enabled** from the **No Answer Forward** field.

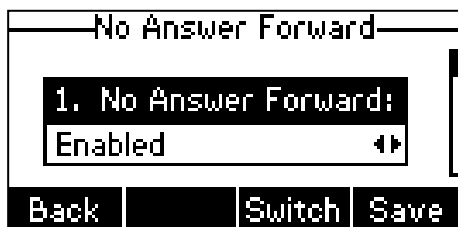

- 2) Enter the destination number you want to forward unanswered incoming calls to in the **Forward to** field.
- 3) Press  $\leftarrow$  or  $\rightarrow$ , or the **Switch** soft key to select the ring time to wait before forwarding from the **After Ring Time** field.  
The default ring time is 12 seconds.
- 4) (Optional.) Enter the no answer forward on code or off code respectively in the

**On Code or Off Code** field.

4. Press the **Save** soft key to accept the change or the **Back** soft key to cancel.

The icon  on the status bar indicates that the call forward is activated.

If the forward on code or off code is configured, the IP phone sends the corresponding code to the server when a certain action takes place. For example, if you set the Always Forward on code to be \*71 (may vary on different servers), and the target number to be 1234. When you activate Always Forward on the IP phone, the IP phone sends \*711234 to the server, and then the server will activate Always Forward feature on the server side, hence being able to get the right status of the extension.

Call forward is configurable via web user interface at the path **Features->Forward&DND**.

**Note**

You can also enter the SIP URI or IP address in the **Forward to** field. For more information on using the SIP URI or IP address, refer to [Placing Calls](#) on page 65.

Call forward is local to the phone, and may be overridden by the server settings. Call forward on code or off code may be different between servers. For more information, contact your system administrator.

**To configure the forward authorized numbers via web user interface:**

1. Click on **Features->Forward&DND**.
2. Select **Enabled** from the pull-down list of **Forward Emergency**.
3. Enter the numbers in the **Forward Authorized Numbers** field.

For multiple numbers, enter a comma between every two numbers.

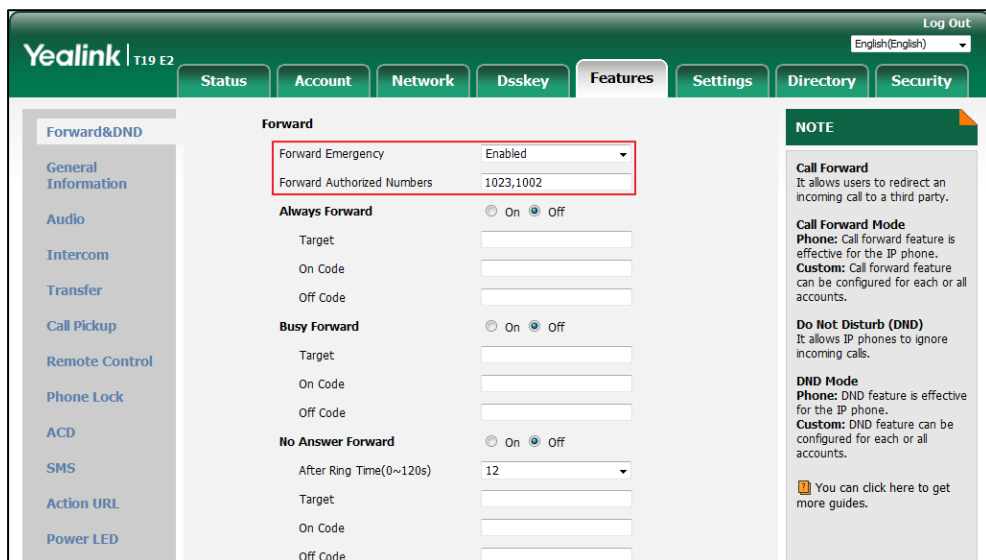

4. Click **Confirm** to accept the change.





When call forward is activated on the phone, the phone cannot forward incoming calls from the numbers specified in the **Forward Authorized Numbers** field.

**Note**

Forward authorized number is configurable via web user interface only.

**To deactivate call forward via phone user interface:**

Do one of the following:

- Press  when the phone is idle.
- Press **Menu->Features->Call Forward**.  
Press  or  to select the desired forwarding type and then press the **Enter** soft key.  
Press  or , or the **Switch** soft key to select **Disabled** to deactivate the call forward.  
Press the **Save** soft key to accept the change.

## Dynamic Forwarding

You can manually forward a call to another number while your phone rings.

**To forward an incoming call to another party:**

1. When the phone is ringing, press the **FWD** soft key.
2. Enter the number you want to forward the incoming call to.

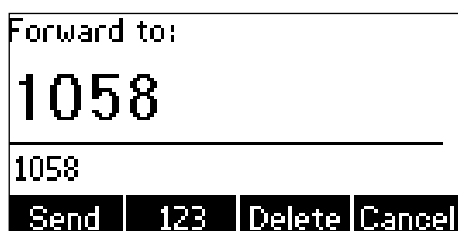

3. Press , , or the **Send** soft key.

The LCD screen prompts a call forward message.

## Call Transfer

You can transfer a call to another party during a call in one of three ways:

- **Blind Transfer:** Transfer a call directly to another party without consulting.
- **Semi-Attended Transfer:** Transfer a call when the target phone is ringing.
- **Attended Transfer (Consultative Transfer):** Transfer a call with prior consulting.

**Allow Trans Exist Call**

You can also transfer a call to another existing call during multiple calls.

**To enable allow trans exist call via web user interface:**

1. Click on **Features->General Information**.
2. Select **Enabled** from the pull-down list of **Allow Trans Exist Call**.

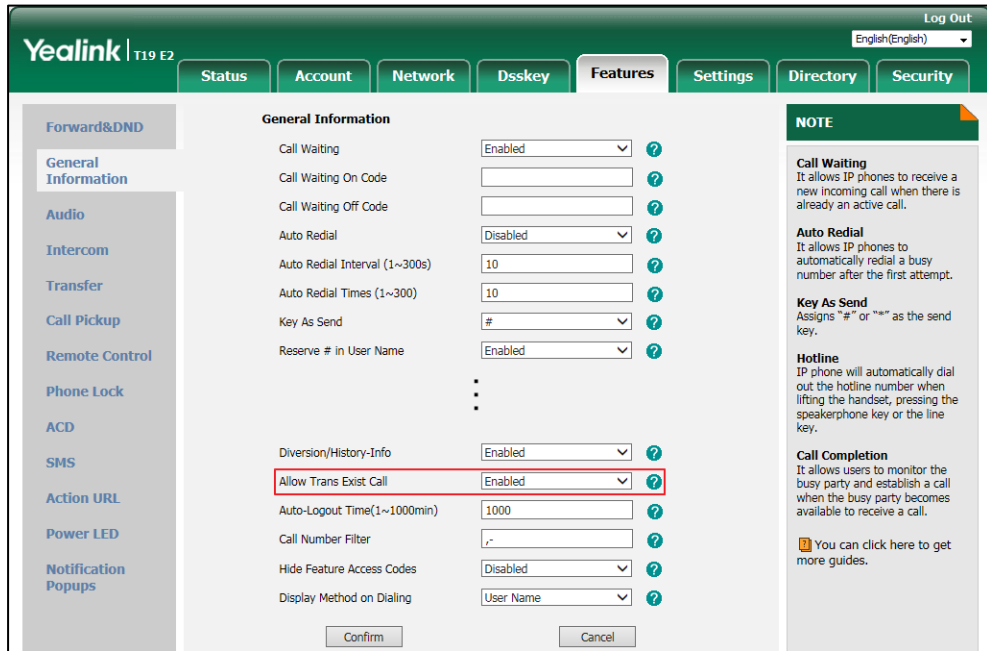

3. Click **Confirm** to accept the change.

## Blind Transfer

**To perform a blind transfer during a call:**

1. Press  or the **Tran** soft key during a call.
2. You can do one of the following:
  - Enter the number you want to transfer the call to.









Press  or the **Tran** soft key to complete the transfer.

If you are using a handset, the transfer can be completed by hanging up the handset.



- Press the **Dir** soft key, and then select **Local Directory**. Select the desired group and search for the contact (Directory should be configured in advance. Refer to [Directory](#) on page 32 for more information).

Press  ,  or the **Send** soft key to complete the transfer.





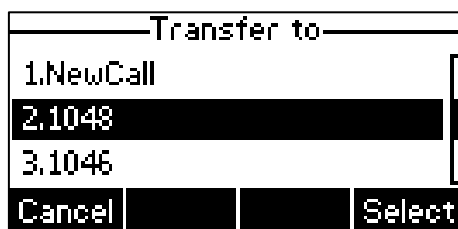

- Press the **Dir** soft key, and then select **History**. Select the desired list and then press  or  to select the entry (Directory should be configured in advance. Refer to [Directory](#) on page 32 for more information).  
Press ,  or the **Send** soft key to complete the transfer.
- Press the **Dir** soft key, and then select **Remote Phone Book**. Select the desired group and search for the contact (Directory should be configured in advance. Refer to [Directory](#) on page 32 and [Remote Phone Book](#) on page 43 for more information).  
Press ,  or the **Send** soft key to complete the transfer.

You can also perform a blind transfer to another existing call when there are multiple calls. Before performing a blind transfer to another existing call, make sure that the Allow Trans Exist Call is enabled. For more information, refer to [Allow Trans Exist Call](#) on page 81.

#### To perform a blind transfer during multiple calls:

1. Press  or the **Tran** soft key during a call.
2. You can do one of the following:
  - Press  or  to select the desired hold call you want to transfer the call to.



- Select **NewCall**, and then enter the number you want to transfer the call to.
  - Enter the number you want to transfer the call to.  
Press  or the **Tran** soft key to complete the transfer.  
If you are using a handset, the transfer can be completed by hanging up the handset.
  - Press the **Dir** soft key, and then select **Local Directory**. Select the desired group and search for the contact (Directory should be configured in advance. Refer to [Directory](#) on page 32 for more information).  
Press ,  or the **Send** soft key to complete the transfer.
  - Press the **Dir** soft key, and then select **History**. Select the desired list and then press  or  to select the entry (Directory should be configured in advance. Refer to [Directory](#) on page 32 for more information).  
Press ,  or the **Send** soft key to complete the transfer.
  - Press the **Dir** soft key, and then select **Remote Phone Book**. Select the desired group and search for the contact (Directory should be configured in advance. Refer to [Directory](#) on page 32 and [Remote Phone Book](#) on page 43 for more information).

information).













Press ,  or the **Send** soft key to complete the transfer.

3. Press  or the **Tran** soft key to complete call transfer.

Then the call is connected to the number to which you are transferring.



## Semi-attended Transfer

### To perform a semi-attended transfer:









1. Press  or the **Tran** soft key during a call.
2. Do one of the following:
  - Enter the number you want to transfer the call to.  
Press  or  to dial out.
  - Press the **Dir** soft key, and then select **Local Directory**. Select the desired group and search for the contact (Directory should be configured in advance. Refer to [Directory](#) on page 32 for more information).  
Press ,  or the **Send** soft key to dial out.
  - Press the **Dir** soft key, and then select **History**. Select the desired list and then press  or  to select the entry (Directory should be configured in advance. Refer to [Directory](#) on page 32 for more information).  
Press ,  or the **Send** soft key to dial out.
  - Press the **Dir** soft key, and then select **Remote Phone Book**. Select the desired group and search for the contact (Directory should be configured in advance. Refer to [Directory](#) on page 32 and [Remote Phone Book](#) on page 43 for more information).  
Press ,  or the **Send** soft key to dial out.
  - If there are multiple calls, you can select the **NewCall** and repeat steps mentioned above to complete transfer.
3. Press  or the **Tran** soft key to complete the transfer when receiving ringback.  
If you are using a handset, the transfer can be completed by hanging up the handset.

## Attended Transfer

### To perform an attended transfer:

1. Press  or the **Tran** soft key during a call.
2. Do one of the following:
  - Enter the number you want to transfer the call to.  
Press  or  to dial out.





- Press the **Dir** soft key, and then select **Local Directory**. Select the desired group and search for the contact (Directory should be configured in advance. Refer to [Directory](#) on page 32 for more information).  
Press ,  or the **Send** soft key to dial out.
  - Press the **Dir** soft key, and then select **History**. Select the desired list and then press  or  to select the entry (Directory should be configured in advance. Refer to [Directory](#) on page 32 for more information).  
Press ,  or the **Send** soft key to dial out.
  - Press the **Dir** soft key, and then select **Remote Phone Book**. Select the desired group and search for the contact (Directory should be configured in advance. Refer to [Directory](#) on page 32 and [Remote Phone Book](#) on page 43 for more information).  
Press ,  or the **Send** soft key to dial out.
  - If there are multiple calls, you can select the **NewCall** and repeat steps mentioned above to complete transfer.
3. After the party answers the call, press  or the **Tran** soft key to complete the transfer.  
If you are using a handset, the transfer can be completed by hanging up the handset.  
You can cancel the transfer before the call is connected by pressing the **Cancel** soft key.



## Call Waiting

You can enable or disable call waiting on the phone. If call waiting is enabled, you can receive another call while there is already an active call on the phone. Otherwise, another incoming call is automatically rejected by the phone with a busy message when there is an active call on the phone. You can also enable or disable the phone to play a warning tone when receiving another call.

### To configure call waiting via phone user interface:

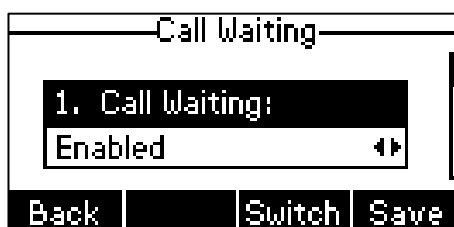
1. Press **Menu->Features->Call Waiting**.
2. Press  or , or the **Switch** soft key to select **Enabled** from the **Call Waiting** field.



3. Press  or , or the **Switch** soft key to select **Enabled** from the **Play Tone** field.
4. (Optional.) Enter the call waiting on code or off code respectively in the **On Code** or **Off Code** field.

If on code or off code is configured, the IP phone will send the corresponding code to activate or deactivate call waiting on the server. It is not available on all servers.

5. Press the **Save** soft key to accept the change or the **Back** soft key to cancel.

Call waiting is configurable via web user interface at the path **Features->General Information**.

**Note**

If on code or off code is not configured, the call waiting may not take effect. It depends on your server. Contact your server administrator for more information.

## Conference

You can create a conference with other two parties using the phone’s local conference. You can create a conference between an active call and a call on hold by pressing the **Conf** soft key. The SIP-T19(P) E2 IP phone also supports network conference.

**Note**

Network conference is not available on all servers. For more information, contact your system administrator.



## Local Conference

The SIP-T19(P) E2 IP phone supports up to 3 parties (including yourself) in a conference call. This is the default method of conference called Local Conference.



**Note**

To set up a local conference call, make sure local conference feature is enabled. For more information, contact your system administrator.

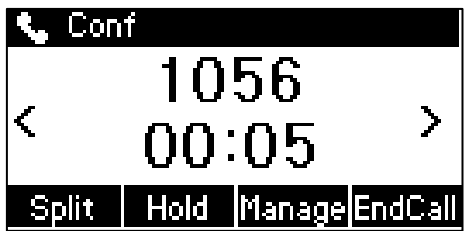

**To set up a local conference call:**

1. Place a call to the first party.
2. When the first party answers the call, press the **NewCall** soft key to place a new call.  
The active call is placed on hold.
3. Enter the number of the second party and then press , , or the **Send** soft key.
4. When the second party answers the call, press the **Conf** soft key again to join all parties in the conference.



You can press  or  to see all parties in the conference.

**During the conference call, you can do the following actions:**

- Press the **Hold** soft key to place the conference on hold.
- Press the **Split** soft key to split the conference call into two individual calls on hold.
- Press the **Manage** soft key, and then press  or  to select the desired party:
  - Press the **FarMute** soft key to mute the party. The muted party can hear everyone, but no one can hear the muted party.
  - Press the **Remove** soft key to remove the party from the conference call.
  - Press the **NewCall** soft key to place a new call.
  - Press the **Back** soft key to return to the previous screen.
- Press  to mute the conference call, all other participants can hear each other, but they cannot hear you.
- Press the **EndCall** soft key to drop the conference call.

## Network Conference

You can use network conference feature on the SIP-T19(P) E2 IP phone to conduct a conference with multiple participants.

This feature allows you to perform the following:

- Join two calls together into a conference call.
- Invite another party into an active conference call.

To use this feature, contact your system administrator for the network conference URI in advance.

**To configure network conference via web user interface:**



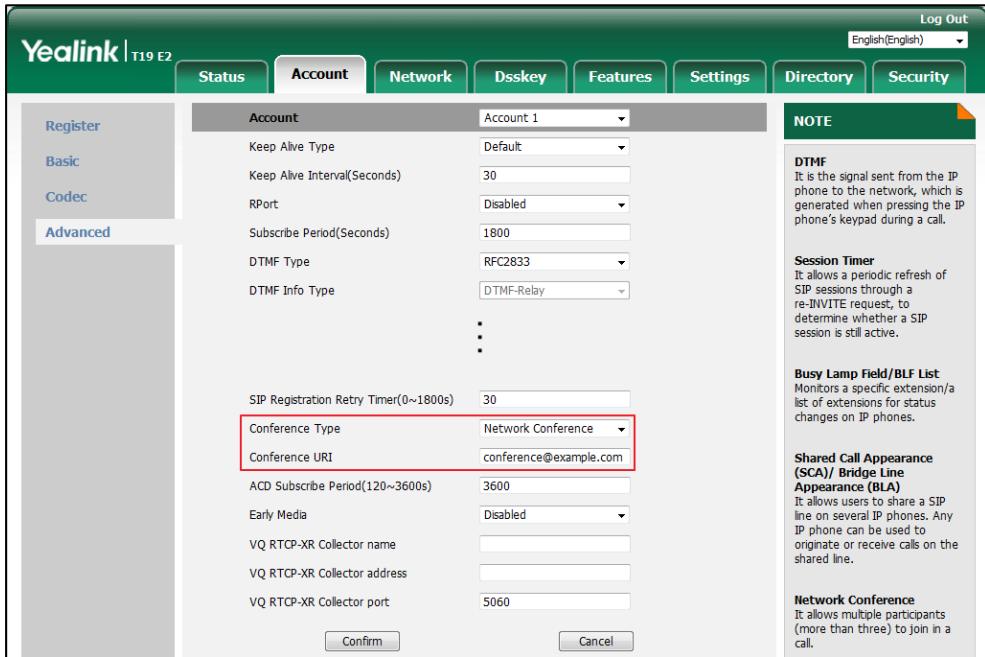

1. Click on **Account->Advanced**.
2. Select **Network Conference** from the pull-down list of **Conference Type**.

- Enter the conference URI (e.g., conference@example.com) in the **Conference URI** field.



- Click **Confirm** to accept the change.

**To set up a network conference call:**

- Place a call to the first party.
- Press the **NewCall** soft key to place a new call.  
The active call is placed on hold.
- Enter the number of the second party and then press  ,  , or the **Send** soft key.
- When the second party answers the call, press the **Conf** soft key to add the second party to the conference.
- Press the **NewCall** soft key to place a new call.
- The conference is placed on hold.
- Enter the number of the new party and then press  ,  , or the **Send** soft key.
- When the new party answers the call, press the **Conf** soft key to add the new party to the conference.
- Repeat steps 5 to 7 until you have added all intended parties.

The procedures to set up a network conference call on specific servers may be different from introduced above. Contact your system administrator for more information.

## Call Park/Retrieve

You can use call park feature to place a call on hold, and then retrieve the call from another phone in the system (for example, a phone in another office or conference room). You can park an active call by pressing the **Park** soft key on the phone. If the call is parked successfully, there is a voice prompt confirming that the call was parked. You can retrieve the parked call by

pressing the **Retrieve** soft key. If the parked call is not retrieved within a period of time defined by the system, the phone performing call park will receive the call back.

**Note** Call park is not available on all servers. Contact your system administrator for more information.

The IP phone supports call park feature under the following modes:

- **FAC mode:** park the call to the local extension or a desired extension through dialing the park code.
- **Transfer mode:** park the call to shared parking lot through performing a blind transfer to a call park number (call park code).

**Note** The call park code and park retrieve code are predefined on the system server. Contact your system administrator for more information.

## FAC Mode

To configure call park feature in FAC mode via web user interface:

1. Click on **Features->Call Pickup**.
2. Select **FAC** from the pull-down list of **Call Park Mode**.
3. Select **Enabled** from the pull-down list of **Call Park**.

If **Enabled** is selected, the **Park** soft key will display on the LCD screen during a call, and the **Retrieve** soft key will display on the dialing screen.

4. (Optional.) Enter the call park code in the **Call Park Code** field.
5. (Optional.) Enter the park retrieve code in the **Park Retrieve Code** field.

The screenshot shows the Yealink T19 E2 web user interface. The 'Features' tab is selected, and the 'Call Pickup' configuration page is displayed. The 'Call Park' section is highlighted with a red box. The configuration is as follows:

Field	Value
Call Park Mode	FAC
Call Park	Enabled
Call Park Code	*68
Park Retrieve Code	*88

The 'NOTE' box on the right contains the following text:

**NOTE**

**Directed Call Pickup**  
Picks up an incoming call on a specific extension.

**Directed Call Pickup**  
Picks up incoming calls within a pre-defined group.

You can configure directed/group call pickup feature for the IP phone.

**Visual Alert for BLF Pickup**  
It allows the supervisor's phone to display a visual prompt when the monitored user receives an incoming call.

**Audio Alert for BLF Pickup**  
It allows the supervisor's phone



6. Click **Confirm** to accept the change.

**Note** If the **Park** or **Retrieve** soft key doesn't appear on the LCD screen, please select **Disabled** from the pull-down list of **Custom Softkey** via web user interface at path **Settings->Softkey Layout**.

**To park a call in FAC mode:**



1. During a call, press the **Park** soft key (You may need to press the **More** soft key to see the **Park** soft key).
  - If the call park code is not configured, you need to enter the call park code (e.g., \*68).

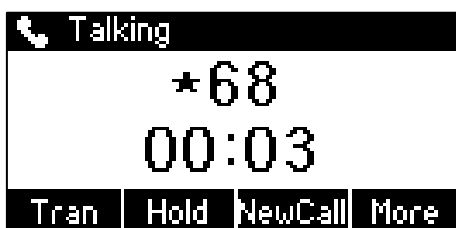

Press  ,  or the **Park** soft key.

- If the call park code is configured, the phone will dial the configured call park code shown as below:





2. Do one of the following:
  - a) If you want to park the call against the local extension.
    - 1) Press  .  
If the call is parked successfully, you will hear a voice prompt confirming that the call is parked.
  - b) If you want to park the call against desired extension.
    - 1) Enter an extension (e.g., 4603) where you want to park the call.
    - 2) Press  or  .  
If the call is parked successfully, you will hear a voice prompt confirming that the call is parked. The call is parked against the extension you entered.

**To retrieve a parked call in FAC mode:**

1. Do one of the following:
  - If the park retrieve code is not configured, dial the park retrieve code (e.g., \*88).
  - If the park retrieve code is configured, press the **Retrieve** soft key on the dialing screen.

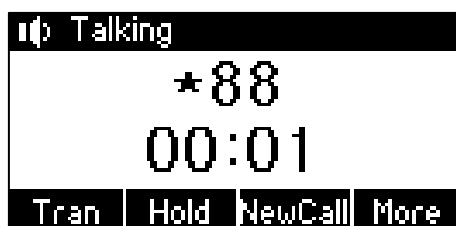
The phone will dial the configured park retrieve code and the Retrieve screen appears as below:



2. Follow the voice prompt, do one of the following:
  - Press  on the phone where the call is parked.
  - Enter the desired extension followed by # (e.g., 4603#) on any phone.

## Transfer Mode

To configure call park feature in transfer mode via web user interface:

1. Click on **Features->Call Pickup**.
2. Select **Transfer** from the pull-down list of **Call Park Mode**.
3. Select **Enabled** from the pull-down list of **Call Park**.
4. (Optional.) Enter the call park code in the **Call Park Code** field.
5. (Optional.) Enter the park retrieve code in the **Park Retrieve Code** field.

If **Enabled** is selected, the **Park** soft key will display on the LCD screen during a call, and the **Retrieve** soft key will display on the dialing screen.

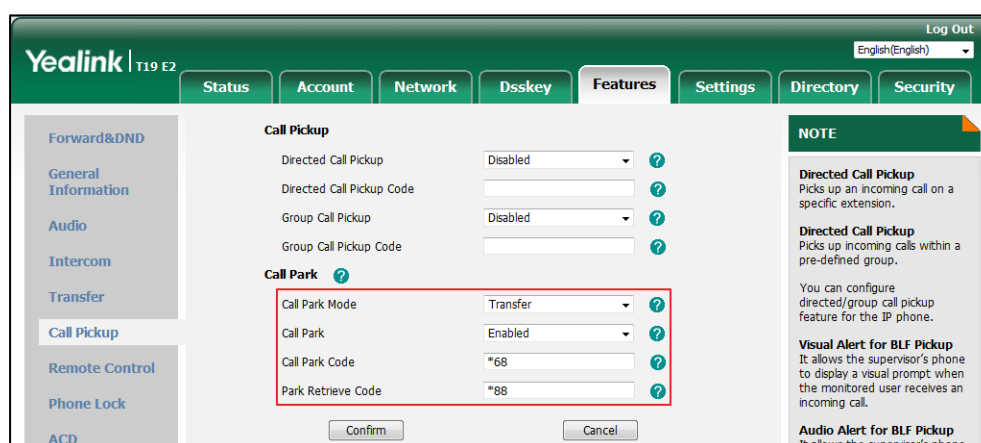



6. Click **Confirm** to accept the change.

**Note** If the **Park** or **Retrieve** soft key doesn't appear on the LCD screen, please select **Disabled** from the pull-down list of **Custom Softkey** via web user interface at path **Settings->Softkey Layout**.

**To park a call in Transfer mode:**

1. During a call, press the **Park** soft key (You may need to press the **More** soft key to see the **Park** soft key).
  - If the call park code is not configured, you need to enter the call park code (e.g., \*01).



Press ,  or the **Park** soft key. The call will be transferred to the shared parking lot.

- If the call park code is configured, the call will be directly transferred to the shared parking lot.

**Note** For some servers, the system will return a specific park retrieve number (park retrieve code) from which the call can be retrieved after parking successfully.

**To retrieve a parked call in Transfer mode:**

1. Do one of the following:
  - If the park retrieve code is not configured, dial the park retrieve code (e.g., \*11).
  - If the park retrieve code is configured, press the **Retrieve** soft key on the dialing screen on the IP phone.

The phone will retrieve the parked call from the shared parking lot.

## Call Pickup

You can use call pickup to answer someone else's incoming call on your phone. The SIP-T19(P) E2 IP phone supports directed call pickup and group call pickup. Directed call pickup is used for picking up a call that is ringing at a target phone number. Group call pickup is used for picking up a call that is ringing at any phone number in a certain group. The pickup group should be predefined, contact your system administrator for more information.

You can pick up an incoming call by using the **DPickup/GPickup** soft key. To use call pickup, you need to configure the call pickup code beforehand on a global or per-line basis via web user interface.

**Note** If there are many incoming calls at the same time, pressing the **GPickup** soft key on the phone will pick up the call that rings first.



## Directed Call Pickup

To enable directed call pickup and configure the directed call pickup code on a global basis via web user interface:

1. Click on **Features->Call Pickup**.
2. Select **Enabled** from the pull-down list of **Directed Call Pickup**.
3. Enter the directed call pickup code in the **Directed Call Pickup Code** field.

The screenshot shows the 'Call Pickup' configuration page in the Yealink T19 E2 web interface. The 'Features' tab is selected. The 'Call Pickup' section has the following settings:

- Directed Call Pickup: Enabled
- Directed Call Pickup Code: \*97
- Group Call Pickup: Enabled
- Group Call Pickup Code: \*98
- Call Park Mode: FAC
- Call Park: Disabled
- Call Park Code: (empty)
- Park Retrieve Code: (empty)

Buttons for 'Confirm' and 'Cancel' are visible at the bottom. A 'NOTE' section on the right provides details about Directed Call Pickup, Visual Alert for BLF Pickup, and Audio Alert for BLF Pickup.

4. Click **Confirm** to accept the change.

To configure the directed call pickup code on a per-line basis via web user interface:

1. Click on **Account->Advanced**.
2. Enter the directed call pickup code in the **Directed Call Pickup Code** field.

The screenshot shows the 'Account' configuration page for 'Account 1' in the Yealink T19 E2 web interface. The 'Advanced' tab is selected. The 'Directed Call Pickup Code' field is highlighted and contains '\*97'. Other fields include:

- Keep Alive Type: Default
- Keep Alive Interval(Seconds): 30
- RPort: Disabled
- Subscribe Period(Seconds): 1800
- DTMF Type: RFC2833
- DTMF Info Type: DTMF-Relay
- Music Server URI: (empty)
- Directed Call Pickup Code: \*97
- Group Call Pickup Code: \*98
- Distinctive Ring Tones: Enabled
- Unregister When Reboot: Disabled
- Out Dialog BLF: Disabled
- VQ RTPC-XR Collector name: (empty)
- VQ RTPC-XR Collector address: (empty)
- VQ RTPC-XR Collector port: 5060

Buttons for 'Confirm' and 'Cancel' are visible at the bottom. A 'NOTE' section on the right provides details about DTMF, Session Timer, Busy Lamp Field/BLF List, Shared Call Appearance (SCA)/ Bridge Line Appearance (BLA), and Network Conference.

3. Click **Confirm** to accept the change.

**To pick up a call directly:**

1. Pick up the handset or press the Speakerphone key (You may need to press the **More** soft key to see the **DPickup** soft key).

The **DPickup** soft key appears on the LCD screen.

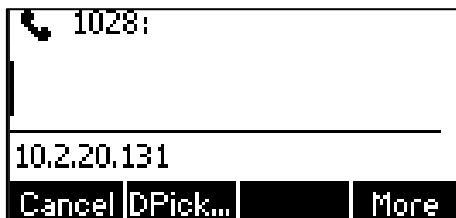

2. Press the **DPickup** soft key on your phone when the target phone receives an incoming call.
3. Enter the phone number which is receiving an incoming call.
4. Press the **DPickup** soft key again.

The call is answered on your phone.

## Group Call Pickup

**To enable group call pickup and configure the group call pickup code on a global basis via web user interface:**

1. Click on **Features->Call Pickup**.
2. Select **Enabled** from the pull-down list of **Group Call Pickup**.
3. Enter the group call pickup code in the **Group Call Pickup Code** field.

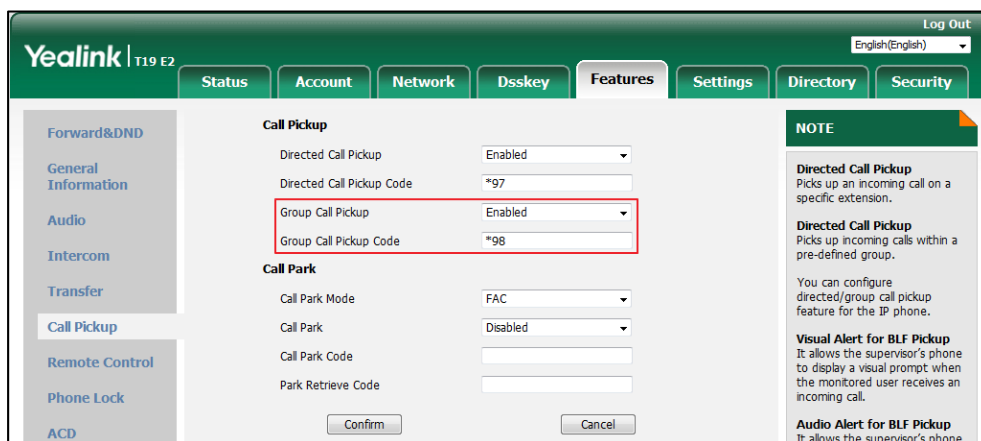

4. Click **Confirm** to accept the change.

**To configure the group call pickup code on a per-line basis via web user interface:**

1. Click on **Account->Advanced**.
2. Enter the group call pickup code in the **Group Call Pickup Code** field.

3. Click **Confirm** to accept the change.

**To pick up a call in the group:**

1. Pick up the handset or press the Speakerphone key.  
The **GPickup** soft key appears on the LCD screen.



2. Press the **GPickup** soft key on your phone when a phone in the group receives an incoming call.  
The call is answered on your phone.

**Note**

The directed call pickup code and group call pickup code are predefined on the system server. Contact your system administrator for more information.

The call pickup code configured on a per-line basis takes precedence over that configured on a global basis.

## Anonymous Call

You can use anonymous call to block your identify and phone number from appearing to the called party when you call someone. For example, you want to call to consult some services, but don't want to be harassed. Anonymous call is configurable on a per-line basis. You can also configure the phone to send anonymous call on/off code to the server to activate/deactivate anonymous call on the server side.

### Note

Anonymous call is not available on all servers. Contact your system administrator for the anonymous call on code and off code.

### To configure anonymous call via phone user interface:

1. Press **Menu**->**Features**->**Anonymous Call**.
2. Press **◀** or **▶**, or the **Switch** soft key to select **Enabled** from the **Local Anonymous** field.

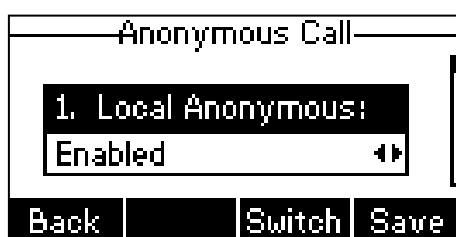

3. (Optional.) Press **◀** or **▶** to select the desired value from the **Send Anony Code** field. The phone will send the configured on code or off code depending on your selection when you enable or disable anonymous call feature on the phone.
4. (Optional.) Enter the anonymous call on code in the **On Code** field.
5. (Optional.) Enter the anonymous call off code in the **Off Code** field.
6. Press the **Save** soft key to accept the change or the **Back** soft key to cancel.

Anonymous call is configurable via web user interface at the path **Account**->**Basic**.

### To place an anonymous call:

1. Using the specific line on the phone to place a call to phone B. The LCD screen of phone B prompts an incoming call from anonymity.



## Anonymous Call Rejection

You can use anonymous call rejection to reject incoming calls from anonymous callers. Anonymous call rejection automatically rejects incoming calls from callers who deliberately block their identities and numbers from being displayed. Anonymous call rejection is configurable on a per-line basis. You can also configure the phone to send anonymous call rejection on/off code to the server to activate/deactivate anonymous call rejection on the server side.

### To configure anonymous call rejection via phone user interface:

1. Press **Menu->Features->Anonymous Call**.
2. Press  $\uparrow$  or  $\downarrow$  to scroll to the **Anony Rejection** field.
3. Press  $\leftarrow$  or  $\rightarrow$ , or the **Switch** soft key to select **Enabled** from the **Anony Rejection** field.

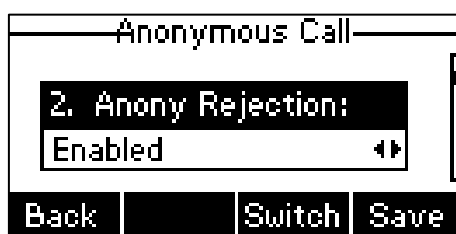

4. (Optional.) Press  $\leftarrow$  or  $\rightarrow$ , or the **Switch** soft key to select the desired value from the **Send Reject Code** field.

The phone will send the configured reject on code or reject off code depending on your selection when you enable or disable anonymous call rejection feature on the phone.

5. (Optional.) Enter the anonymous call rejection on code in the **On Code** field.
6. (Optional.) Enter the anonymous call rejection off code in the **Off Code** field.
7. Press the **Save** soft key to accept the change or the **Back** soft key to cancel.

Anonymous call rejection is configurable via web user interface at the path **Account->Basic**.



# Advanced Phone Features

---

This chapter provides operating instructions for the advanced features of the SIP-T19(P) E2 IP phone. Topics include:

- [Hot Desking](#)
- [Intercom](#)
- [Multicast Paging](#)
- [Music on Hold \(MoH\)](#)
- [Shared Call Appearance \(SCA\)](#)
- [Bridged Line Appearance \(BLA\)](#)
- [Messages](#)

If you require additional information or assistance with your new phone, contact your system administrator.

## Hot Desking

Hot desking originates from the definition of being the temporary physical occupant of a workstation or surface by a particular employee. A primary motivation for hot desking is cost reduction. This feature is regularly used in places where not all the employees are in the office at the same time, or not in the office for very long, which means that actual personal offices would be often vacant, consuming valuable space and resources.

You can use hot desking on the SIP-T19(P) E2 IP phone to log out of the existing accounts and then log into a new account. As a result, many users can share the phone resource at different times. To use this feature, you need to configure a hot desking key in advance.

### Note

Hot desking is not available on all servers. Contact your system administrator for more information.

### To configure a hot desking key via web user interface:

1. Click on **Dsskey->Programable Key**.
2. Select the desired programable key.

3. Select **Hot Desking** from the pull-down list of **Type**.
4. (Optional.) Enter the string that will appear on the LCD screen in the **Label** field.  
Label is configurable only when customizing SoftKey (1-4).

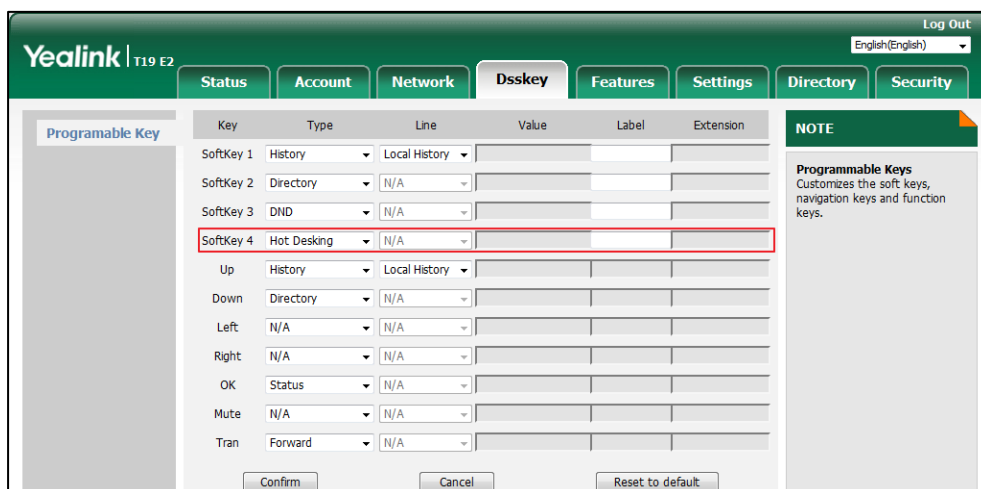

5. Click **Confirm** to accept the change.

**To use hot desking:**

1. Press the hot desking key when the phone is idle.

The LCD screen prompts the following warning:



2. Press the **OK** soft key, registration configurations of all accounts on the phone will be cleared immediately.

The login wizard will be displayed as below:



3. Enter the login information in each field.
4. Press the **Save** soft key to login or the **Cancel** soft key to cancel.



## Intercom

Intercom is a useful feature in an office environment to quickly connect with the operator or the secretary. You can press the intercom key to automatically connect with a preconfigured target extension for outgoing intercom calls, and the target extension will automatically answer incoming intercom calls by default.

**Note** Intercom is not available on all servers. Contact your system administrator for more information.

## Configuring the Intercom Feature on the IP Phone

### Configuring an Intercom Key

To configure an intercom key via web user interface:

1. Click on **Dsskey->Programable Key**.
2. Select the desired programable key.
3. Select **Intercom** from the pull-down list of **Type**.
4. Enter the target extension number in the **Value** field.
5. (Optional.) Enter the string that will appear on the LCD screen in the **Label** field.

Label is configurable only when customizing SoftKey (1-4).

Key	Type	Line	Value	Label	Extension
SoftKey 1	History	Local History			
SoftKey 2	Directory	N/A			
SoftKey 3	DND	N/A			
SoftKey 4	Intercom	N/A	1029		
Up	History	Local History			
Down	Directory	N/A			
Left	N/A	N/A			
Right	N/A	N/A			
OK	Status	N/A			
Mute	N/A	N/A			
Tran	Forward	N/A			

**NOTE**  
**Programmable Keys**  
 Customizes the soft keys, navigation keys and function keys.  
 You can click here to get more guides.

6. Click **Confirm** to accept the change.

### Incoming Intercom Calls

The SIP-T19(P) E2 IP phone supports automatically to answer an incoming intercom call by default. The phone automatically plays a warning tone when it receives an incoming intercom call. In addition, you can enable the phone to mute the microphone when it automatically answers an incoming intercom call. You can also enable the phone to automatically answer an incoming intercom call while there is already an active call on the phone. The active call is then

placed on hold.

Intercom features you need to know:

Intercom Feature	Description
Intercom Allow	Enable or disable the IP phone to answer an incoming intercom call.
Intercom Mute	Enable or disable the IP phone’s microphone for intercom calls.
Intercom Tone	Enable or disable the IP phone to play a warning tone when it receives an incoming intercom call.
Intercom Barge	Enable or disable the IP phone to automatically answer an incoming intercom call while there is already an active call on the phone.

**Intercom Allow**

You can enable or disable the phone to answer an incoming intercom call. If Intercom Allow is enabled, the phone will automatically answer an incoming intercom call. If Intercom Allow is disabled, the phone will handle an incoming intercom call like a normal call instead of directly rejecting it. Intercom Allow is enabled by default.

**Note**

Your administrator can set a period of delay time before the phone automatically answers intercom calls. Contact your system administrator for more information.

**Intercom Mute**

You can mute or un-mute the phone’s microphone for intercom calls automatically. If Intercom Mute is enabled, the microphone will be muted for intercom calls. If Intercom Mute is disabled, the microphone will work for intercom calls. Intercom Mute is disabled by default.

**Intercom Tone**

You can enable or disable the phone to play a warning tone when receiving an intercom call. If Intercom Tone is enabled, the phone will play a warning tone before answering the intercom call. If Intercom Tone is disabled, the phone will automatically answer the intercom call without warning. Intercom Tone is enabled by default.

**Intercom Barge**

You can enable or disable the phone to automatically answer an incoming intercom call while there is already an active call on the phone. If Intercom Barge is enabled, the phone will automatically answer the intercom call and place the active call on hold. If Intercom Barge is disabled, the phone will handle an incoming intercom call like a waiting call. Intercom Barge is disabled by default.

**To configure intercom features via phone user interface:**

1. Press **Menu->Features->Intercom.**

2. Make the desired changes.

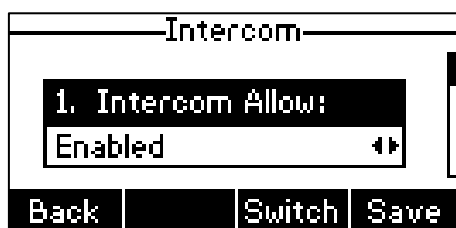

3. Press the **Save** soft key to accept the change or the **Back** soft key to cancel.

Intercom features are configurable via web user interface at the path **Features->Intercom**.

## Using Intercom

### To place an intercom call when the target phone is idle:

1. Press the intercom key.

The target extension plays a warning tone and automatically answers the call in the hands-free (speakerphone) mode by default.

## Multicast Paging

You can use multicast paging to quickly and easily broadcast time sensitive announcements to users who are listening to a specific multicast group and a specific channel. You can configure the paging list key on the phone, which allows you to send a Real Time Transport Protocol (RTP) stream to the pre-configured multicast address(es) and channel(s) without involving SIP signaling. You can configure the phone to receive an RTP stream from pre-configured multicast listening address(es) and channel(s) without involving SIP signaling. You can specify up to 31 multicast listening addresses and channels.

The following describes 31 paging channels:

- **0:** You can broadcast audio to channel 0. Note that the Yealink IP phones running old firmware version (old paging mechanism) can be regarded as listening to channel 0. It is the default channel.
- **1 to 25:** You can broadcast audio to a specific channel. We recommend that you specify these channels when broadcasting with Polycom IP phones which have 25 channels you can listen to.
- **26 to 30:** You can broadcast audio to a specific channel. We recommend that you specify these channels when broadcasting with Yealink IP phones running new firmware version (new paging mechanism).

The IP phones will automatically ignore all incoming multicast paging calls on the different channel.

## Sending RTP Stream

**To configure a multicast paging key via web user interface:**

1. Click on **Dsskey->Programable Key**.
2. Select the desired programable key.
3. Select **Paging** from the pull-down list of **Type**.
4. Enter the multicast IP address and port number (e.g., 224.5.6.20:10008) in the **Value** field.  
The valid multicast IP addresses range from 224.0.0.0 to 239.255.255.255.
5. (Optional.) Enter the string that will appear on the LCD screen in the **Label** field.  
Label is configurable only when customizing SoftKey (1-4).
6. Enter the desired channel in the **Channel** field.  
The valid channel ranges from 0 to 30.

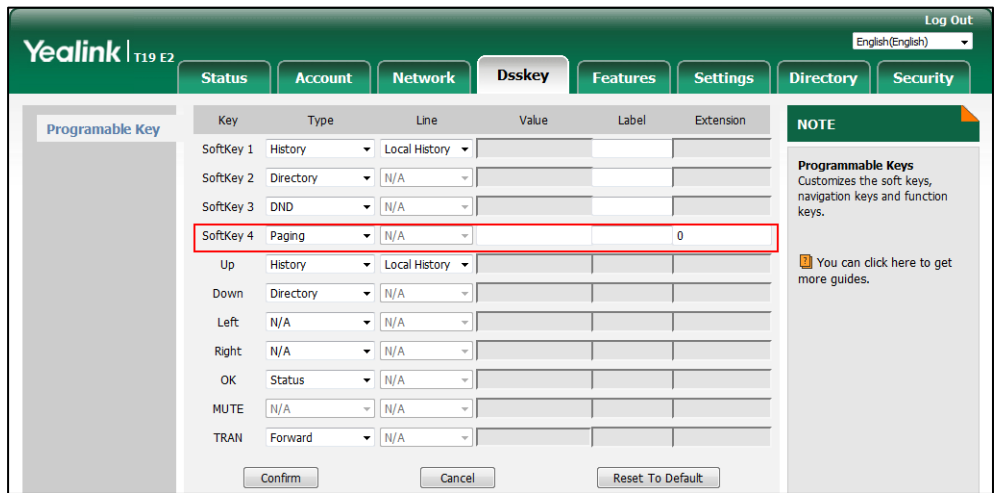

7. Click **Confirm** to accept the change.

**To configure a paging list key via web user interface:**

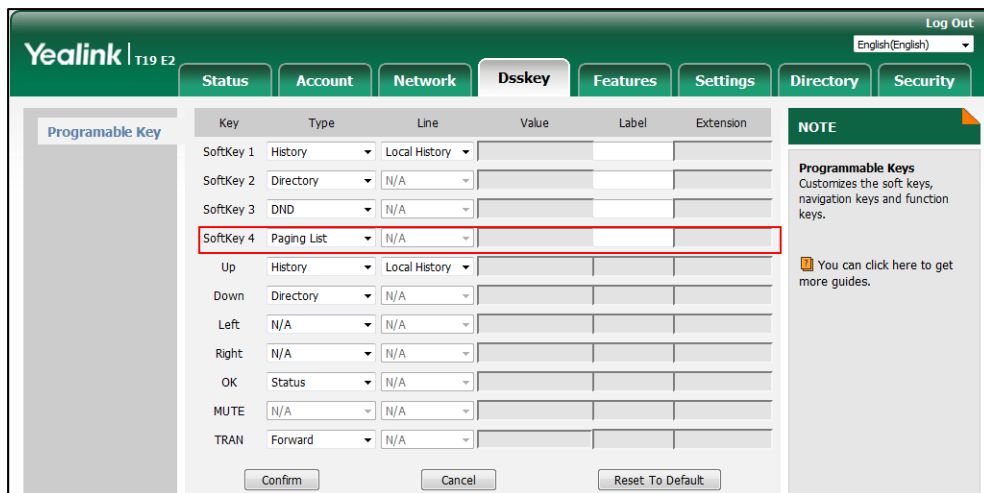

1. Click on **Dsskey->Programable Key**.
2. Select the desired programable key.
3. Select **Paging List** from the pull-down list of **Type**.
4. (Optional.) Enter the string that will appear on the LCD screen in the **Label** field.

Label is configurable only when customizing SoftKey (1-4).



5. Click **Confirm** to accept the change.

#### To configure paging list via phone user interface:

1. Press the paging list key when the phone is idle.  
If the paging list key is not configured, you can also press **Menu->Features->Paging List** to enter the paging list.
2. Press  or  to select a desired paging group.  
The default tag is Empty if it is not configured before.

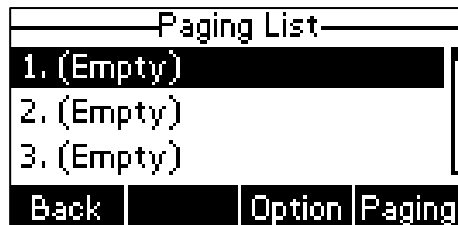

3. Press the **Option** soft key and then press the **Edit** soft key.
4. Enter the multicast IP address and port number (e.g., 224.5.6.20:10008) in the **Address** field.

The valid multicast IP addresses range from 224.0.0.0 to 239.255.255.255.



5. Enter the group name in the **Label** field.
6. Enter the desired channel in the **Channel** field.

The valid channel ranges from 0 to 30.

7. Press the **Save** soft key to accept the change.
8. Repeat steps 2 to 7, you can add more paging groups.

Paging list is configurable via web user interface at the path **Directory->Multicast IP**.

**To delete a paging group via phone user interface:**

1. Press the paging list key when the phone is idle.
2. Press  $\uparrow$  or  $\downarrow$  to select a desired paging group.
3. Press the **Option** soft key and then press the **Delete** soft key.

The LCD screen prompts "Delete selected paging group?".

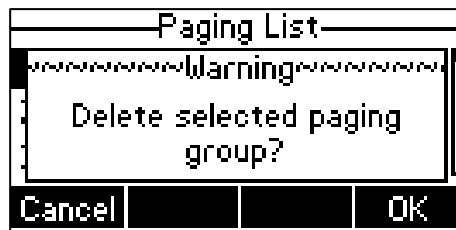

4. Press the **OK** soft key to accept the change or the **Cancel** soft key to cancel.

If you want to delete all paging groups, you can press the **Del All** soft key.

## Receiving RTP Stream

You can configure the phone to receive a Real Time Transport Protocol (RTP) stream from the pre-configured multicast address(es) and channel(s) without involving SIP signaling. You can specify up to 31 multicast addresses and channels that the phone listens to on the network.

**Note**

RTP stream is listened in the hands-free (speakerphone) mode by default. If you want to listen the RTP stream using the engaged audio device (speakerphone, handset or headset), contact your system administrator for more information.

Fixed volume to play RTP stream for specified paging group is configurable by your system administrator.

How the phone handles incoming multicast paging calls depends on Paging Barge, Ignore DND and Paging Priority Active parameters configured via web user interface.

**Paging Barge**

The paging barge parameter defines the priority of the voice call in progress. If the priority of an incoming multicast paging call is lower than that of the active call, it will be ignored automatically. Valid values in the Paging Barge field:

- **1 to 31:** Define the priority of the active call, 1 with the highest priority, 31 with the lowest.
- **Disabled:** The voice call in progress will take precedence over all incoming paging calls.

### Ignore DND

The ignore DND parameter defines the lowest priority of multicast listening address from which the phone can receive an RTP stream when DND is activated. If a priority is selected from the pull-down list of Ignore DND, the phone will ignore incoming multicast paging calls with lower priorities when DND is activated in phone mode. Valid values in the Ignore DND field:

- **1 to 31:** Define the lowest priority of the multicast listening address from which the phone can receive an RTP stream, 1 with the highest priority, 31 with the lowest.
- **Disabled:** All the incoming multicast paging calls will be ignored when DND is activated.

The phone will automatically answer all incoming multicast paging calls when DND is activated in custom mode.

### Paging Priority Active

The paging priority active parameter decides how the phone handles incoming multicast paging calls when there is already a multicast paging call on the phone. If enabled, the phone will ignore incoming multicast paging calls with lower priorities, otherwise, the phone will answer incoming multicast paging calls automatically and place the previous multicast paging call on hold. If disabled, the phone will automatically ignore all incoming multicast paging calls.

#### To configure multicast listening addresses via web user interface:

1. Click on **Directory->Multicast IP**.
2. Select the desired value from the pull-down list of **Paging Barge**.
3. Select the desired value from the pull-down list of **Ignore DND**.
4. Select the desired value from the pull-down list of **Paging Priority Active**.
5. Enter the multicast IP address(es) and port number (e.g., 224.5.6.20:10008) which the phone listens to for incoming RTP multicast in the **Listening Address** field.
6. (Optional.) Enter the label in the **Label** field.  
Label will appear on the LCD screen when receiving the multicast RTP stream.
7. Select the desired channel to listen from the pull-down list of **Channel**.

The default channel is 0.

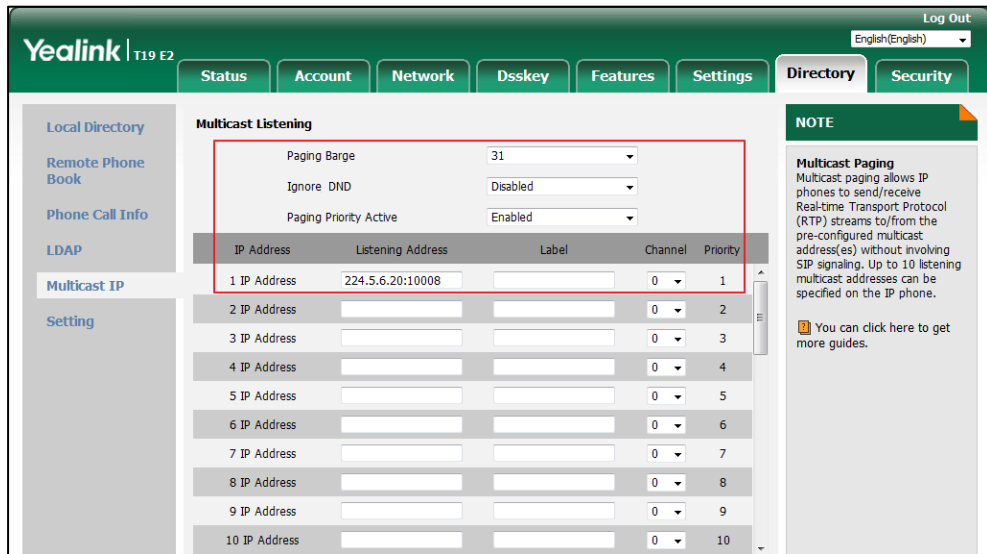

8. Click **Confirm** to accept the change.

**Note** The priorities of listening addresses are predefined: 1 with the highest priority, 31 with the lowest. Multicast listening addresses are configurable via web user interface only.

## Using Multicast Paging

**To send RTP stream via a multicast paging key when the receiver's phone is idle:**

1. Press the multicast paging key when the phone is idle.

The phone sends RTP to a preconfigured multicast address (IP: Port).

Both the sender's and receiver's phones play a warning tone and the receiver automatically answers the multicast RTP session in the hands-free (speakerphone) mode.

The following figure shows a multicast RTP session on the phone:



2. You can do the following:

- To place the current multicast RTP session on hold, press the **Hold** soft key.

The sender's phone places the multicast RTP session on hold and receiver's phone releases the session.

To resume the held multicast RTP session, press the **Resume** soft key.





The multicast RTP session is established again.

- To end the multicast RTP session, press the **EndCall** soft key.

#### Note

Multicast RTP is one way only from the sender to the multicast address(es) (receiver). For outgoing RTP multicasts, all other existing calls on the phone will be placed on hold.

#### To send RTP stream via a paging list key when the receiver's phone is idle:

1. Press the paging list key when the phone is idle.
2. Press  or  to select the desired paging group.



3. Press  or the **Paging** soft key to send RTP.
4. You can do the following:

- To place the current multicast RTP session on hold, press the **Hold** soft key.

The sender's phone places the multicast RTP session on hold and receiver's phone releases the session.

To resume the held multicast RTP session, press the **Resume** soft key.

The multicast RTP session is established again.

- To end the multicast RTP session, press the **EndCall** soft key.

## Music on Hold (MoH)

Music on hold (MoH) is the business practice of playing recorded music to fill the silence that would be heard by the party placed on hold. To use this feature, you should specify a SIP URI pointing to a Music on Hold Server account. When a call is placed on hold, the phone will send a SIP INVITE message to the Music on Hold Server account. The Music on Hold Server account automatically answers the SIP INVITE messages and immediately plays audio from some source located anywhere (LAN, Internet) to the held party. Contact your system administrator for the SIP URI.

#### Note

If your server supports the MOH feature, you can also upload the custom music file into it directly. For more information, contact your service provider.

#### To configure music on hold server via web user interface:

1. Click on **Account->Advanced**.

- Enter the SIP URI (e.g., sip:moh@sp.com) in the **Music Server URI** field.

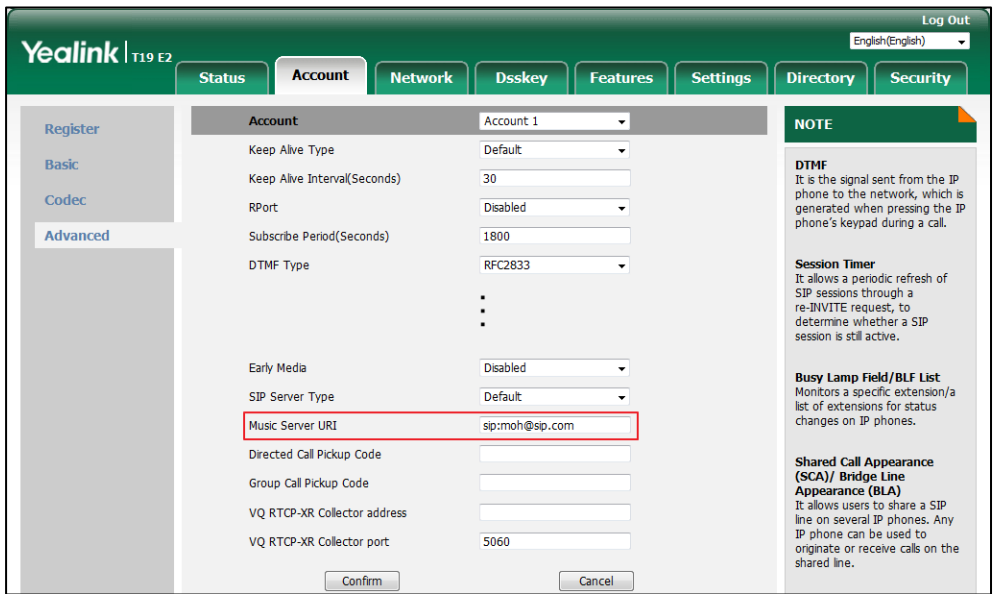

- Click **Confirm** to accept the change.

When you have placed a call on hold, the held party can hear the music.

**Note**

For this feature to function, all involved parties cannot use encrypted RTP (SRTP).  
 Music on hold server is configurable via web user interface only.

## Shared Call Appearance (SCA)

You can use SCA feature to share an extension which can be registered on two or more IP phones at the same time. The shared line is indicated by a different line icon.

In the following figure, the registered line is shared:

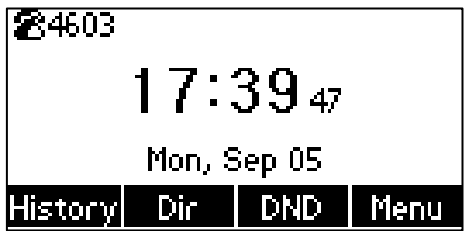

If two phones share a line, an incoming call to this extension will cause both phones to ring simultaneously. The incoming call can be answered on either phone but not both.

This feature is very useful in the boss and secretary scenario. For example, the secretary can share the boss's extension on her phone. When there is an incoming call to the extension of the boss, both the phones of the boss and the secretary will ring simultaneously. Either the boss or the secretary can answer the call.

## Configuring SCA Feature on the IP Phone

You can configure a primary account on the IP phone and other alternate accounts on the other IP phones. For example, party A, party B share the account 4603, phone A registers the primary account 4603, phone B registers the alternate account 4603\_1, phone C registers the account 4604.

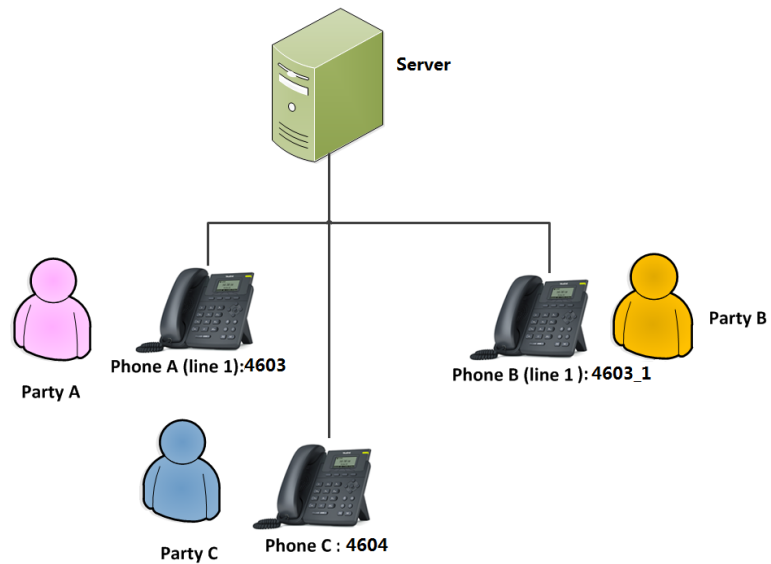

**To configure the shared line settings on phone A via web user interface:**

1. Register the account 4603.

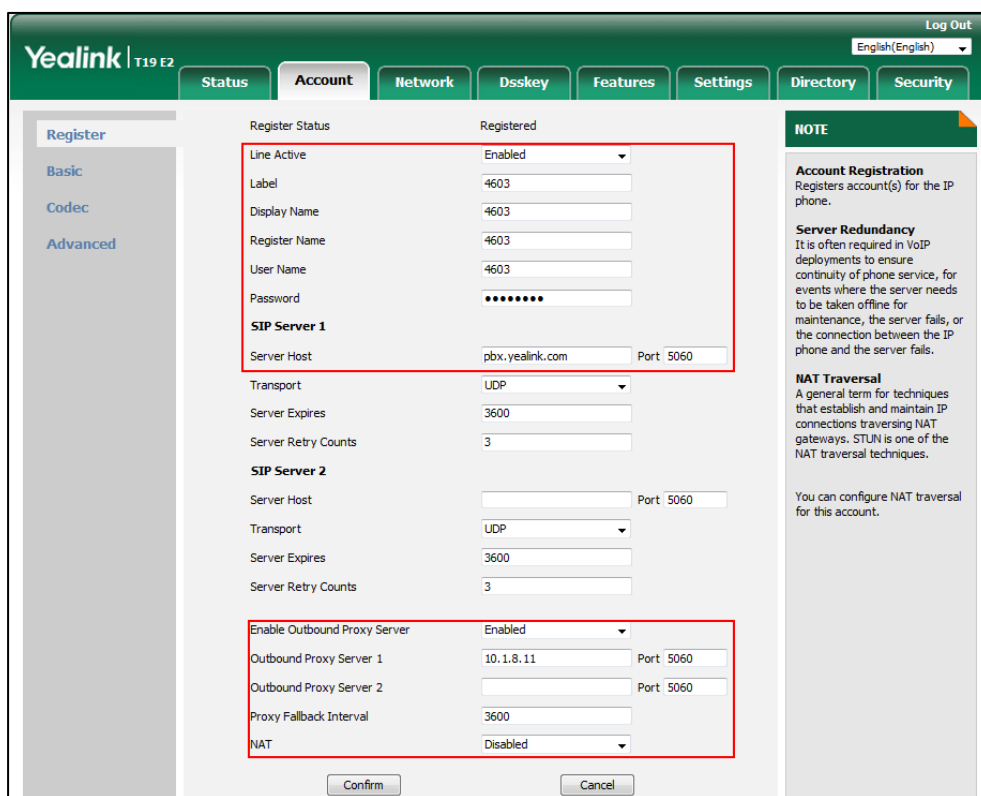

2. Click on **Advanced**, and then select **Shared Call Appearance** from the pull-down list of **Shared Line**.

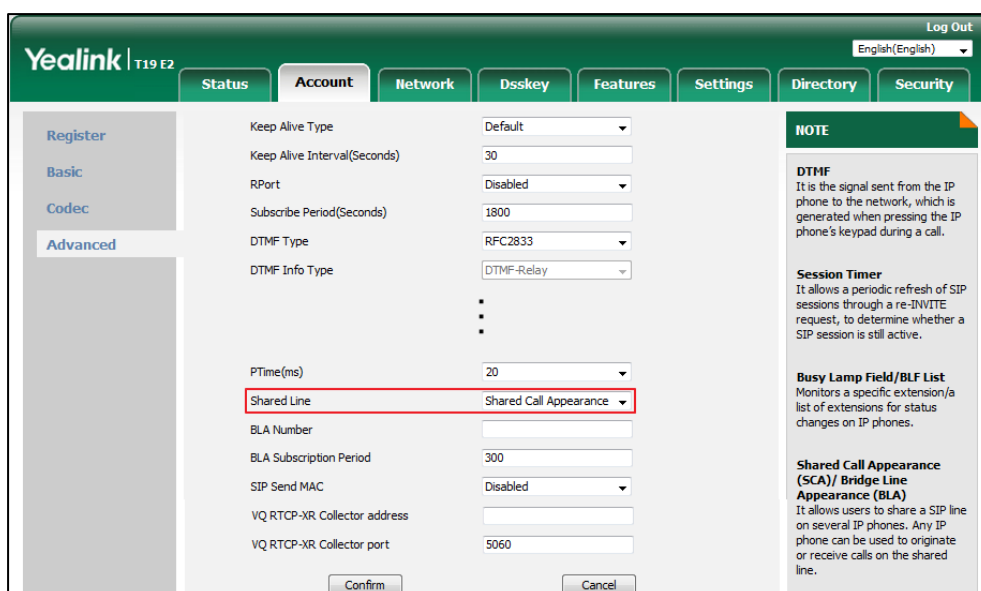

3. Click **Confirm** to accept the change.

**To configure the shared line settings on phone B via web user interface:**

1. Register the alternate account 4603\_1.  
(Enter the primary account 4603 in the **Register Name** field.)

2. Click on **Advanced**, and then select **Shared Call Appearance** from the pull-down list of **Shared Line**.

3. Click **Confirm** to accept the change.

## Using SCA Feature on the IP Phone

This section provides you with detailed information on using the SIP-T19(P) E2 IP phone in a SCA scenario.



You can do the following using SIP-T19(P) E2 IP phone in a SCA scenario:

- Placing calls
- Answering calls
- Place a call on hold
- Retrieving a held call

### Placing Calls



You can have one call or multiple calls on the shared line.

#### To place a call on the shared line:

1. Enter the desired number using the keypad when the phone is idle.
2. Press , , or the **Send** soft key.

#### To place multiple calls on the shared line:

You can have more than one call on the shared line. To place a new call when there is an active call on phone A, do one of the following on phone A:

1. Press the **Hold** soft key. The original call is placed on hold.
2. Press the **NewCall** soft key to enter the dialing screen.
3. Enter the desired number using the keypad.
4. Press , , or the **Send** soft key.

Phone A will dial the entered number.





### Answering Calls

You can have one call or multiple calls on the shared line. Incoming calls will be distributed evenly among the available shared line.

#### To answer a call on the shared line:

When an incoming call arrives on the shared line, the phone A and phone B will ring simultaneously. You can answer the incoming call on either phone A or phone B but not both.

Do one of the following on phone A or phone B:

- Press ,  or the **Answer** soft key on phone A.  
Phone B stops ringing.
- Press ,  or the **Answer** soft key on phone B.  
Phone A stops ringing.

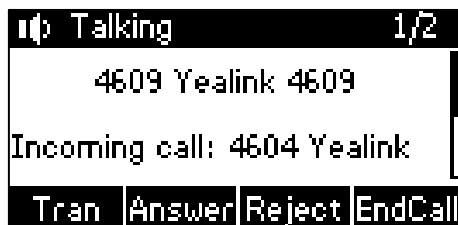

**To answer multiple calls on the shared line:**

An incoming call arrives on the shared line when there is an active call on phone A. You can answer the incoming call on either phone A or phone B. The LCD screen of phone A displays the information of the incoming call (e.g., "Incoming call: 4604 Yealink").



**Note** Make sure call waiting feature is enabled on phone A. For more information, refer to [Call Waiting](#) on page 85.

Do one of the following on phone A:

- Press the **Answer** soft key. Phone B stops ringing.
- Press  to access the new call.  
Press  or the **Answer** soft key. Phone B stops ringing.  
The incoming call is answered and the original call is placed on hold.

You can also answer the call on phone B:

1. Press  or the **Answer** soft key. Phone A stops ringing.

## Placing a Call on Hold

### To place a call on hold:

1. Press the **Hold** soft key on phone A when party A and party C are talking.  
The shared line call is placed on hold.

## Retrieving a Held Call

If there is a held call between phone A and phone C, you can retrieve a held call on phone A.

### To retrieve the held call on phone A:

1. Press the **Resume** soft key on phone A.  
The conversation between phone A and phone C is retrieved.

## Bridged Line Appearance (BLA)

BLA allows users to share a SIP line on two or more IP phones. Users can monitor the specific extension (BLA number) for status changes on each IP phone. To use this feature, a BLA group

should be pre-configured on the server and one of them is specified as a BLA number. BLA depends on support from a SIP server.

In the following figure, the registered line is shared:

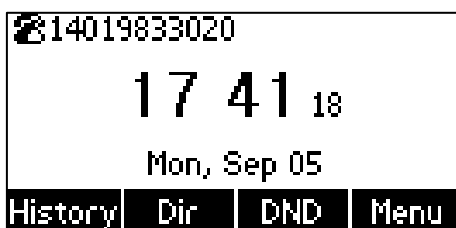

Any IP phone can be used to originate or receive calls on the bridged line. An incoming call to the BLA number can be presented to multiple phones in the group simultaneously. The incoming call can be answered on any IP phone of the group but not all.

## Configuring BLA Feature on the IP Phone

You can share a BLA number on two or more phones. For example, phone A registers the account 14019833020 and assigns BLA number, phone B registers the account 10462190020 and assigns BLA number, phone C registers the account 14755608020. Phone A and phone B share the BLA number 14084588327.

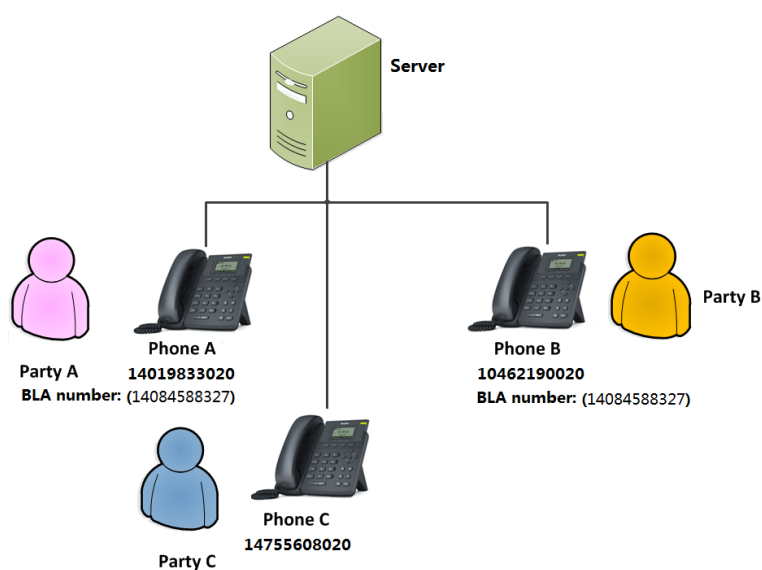



**To register an account and configure BLA feature on phone A via web user interface:**

1. Register the account 14019833020.

The screenshot shows the Yealink T19 E2 web interface. The 'Account' tab is selected, and the 'Register' section is active. The 'Line Active' dropdown is set to 'Enabled'. The 'SIP Server 1' section shows 'Server Host' as sip.ringcentral.com and Port 5060. The 'Enable Outbound Proxy Server' dropdown is set to 'Enabled', and 'Outbound Proxy Server 1' is set to sip114.ringcentral.com and Port 5099. The 'NAT' dropdown is set to 'Disabled'. A 'NOTE' section on the right provides information about Account Registration, Server Redundancy, and NAT Traversal.

2. Click on **Advanced**, and then select **Draft BLA** from the pull-down list of **Shared Line**.
3. Enter the desired number in the **BLA Number** field.

The screenshot shows the Yealink T19 E2 web interface. The 'Account' tab is selected, and the 'Advanced' section is active. The 'Shared Line' dropdown is set to 'Draft BLA'. The 'BLA Number' field is set to 14084588327. The 'RTP Encryption(SRTP)' dropdown is set to 'Disabled'. The 'PTime(ms)' dropdown is set to 20. The 'VQ RTPC-XR Collector port' is set to 5060. A 'NOTE' section on the right provides information about DTMF, Session Timer, Busy Lamp Field/BLF List, Shared Call Appearance (SCA)/ Bridge Line Appearance (BLA), and Network Conference.

4. Click **Confirm** to accept the change.

**To register an account and configure BLA feature on phone B via web user interface:**

1. Register the account 10462190020.

The screenshot shows the 'Account' configuration page for 'Account 1'. The 'Line Active' field is set to 'Enabled'. The 'SIP Server 1' section shows 'Server Host' as sip.ringcentral.com and Port 5060. The 'Enable Outbound Proxy Server' field is set to 'Enabled', and 'Outbound Proxy Server 1' is set to sip214.ringcentral.com and Port 5099. The 'NAT' field is set to 'Disabled'. A 'NOTE' section on the right provides information about Account Registration, Server Redundancy, and NAT Traversal.

2. Click on **Advanced**, and then select **Draft BLA** from the pull-down list of **Shared Line**.
3. Enter the desired number in the **BLA Number** field.

The screenshot shows the 'Advanced' configuration page for 'Account 1'. The 'Shared Line' field is set to 'Draft BLA' and the 'BLA Number' field is set to '14084588327'. The 'Keep Alive Type' is set to 'Default', 'Keep Alive Interval(Seconds)' is 30, 'RPort' is 'Disabled', 'Subscribe Period(Seconds)' is 1800, 'DTMF Type' is 'RFC2833', and 'DTMF Info Type' is 'DTMF-Relay'. The 'RTP Encryption(SRTP)' is 'Disabled', 'PTime(ms)' is 20, 'BLA Subscription Period' is 300, 'SIP Send MAC' is 'Disabled', and 'VQ RTPC-XR Collector port' is 5060. A 'NOTE' section on the right provides information about DTMF, Session Timer, Busy Lamp Field/BLF List, Shared Call Appearance (SCA)/ Bridge Line Appearance (BLA), and Network Conference.

4. Click **Confirm** to accept the change.

## Using BLA Feature on the IP Phone

This section provides you with detailed information on using the SIP-T19(P) E2 IP phone in a BLA scenario.



You can do the following using SIP-T19(P) E2 IP phone in a BLA scenario:

- Placing calls
- Answering calls
- Place a call on hold
- Retrieving a held call

### Placing Calls



You can have one call or multiple calls on the shared line.

#### To place a call on the shared line:

1. Enter the desired number using the keypad when the phone is idle.
2. Press , , or the **Send** soft key.

#### To place multiple calls on the shared line:

You can have more than one call on the shared line. To place a new call when there is an active call on phone A, do one of the following on phone A:





1. Press the **Hold** soft key. The original call is placed on hold.
2. Press the **NewCall** soft key to enter the dialing screen.
3. Enter the desired number using the keypad.
4. Press , , or the **Send** soft key.

Phone A will dial the entered number.

### Answering Calls

When the phone C dials the BLA number "14084588327", an incoming call will arrive on the bridged line. The phone A and phone B ring simultaneously. You can answer the incoming call on either phone A or phone B but not both.

Do one of the following on phone A or phone B:

- Press ,  or the **Answer** soft key on phone A.  
Phone B stops ringing.
- Press ,  or the **Answer** soft key on phone B.  
Phone A stops ringing.

## Placing a Call on Hold

### To place a call on hold:

1. Press the **Hold** soft key on phone A when party A and party C are talking.  
The bridged line call is placed on hold.

## Retrieving a Held Call

If there is a held call between phone A and phone C, you can retrieve a held call on phone A.

### To retrieve the held call on phone A:

1. Press the **Resume** soft key on phone A.  
The conversation between phone A and phone C is retrieved.

## Messages

### Short Message Service (SMS)

You can send and receive text messages using the SIP-T19(P) E2 IP phone. New text messages can be indicated both acoustically and visually. When receiving a new text message, the phone will play a warning tone. The power indicator LED will slowly flash yellow, and the LCD screen will prompt “n New Text Message(s)” (“n” indicates the number of unread text messages. e.g., 1 New Text Message(s)) and a flashing icon .



#### Note

When the phone receives a text message, the text message prompt window will pop up by default. If you want to disable this feature, contact your system administrator for more information.

You can store text messages in your phone's Inbox, Sentbox, Outbox or Draftbox. Each of the boxes can store up to 100 text messages. If the number of the text messages in one box is more than 100, the phone will directly delete the oldest text message in the box.

#### Note

SMS is not available on all servers. Contact your system administrator for more information.

**To read a text message:**

1. Press **Menu->Message->Text Message->Inbox**.



2. Select the desired message and then press the **View** soft key.

**Note**

If the phone prompts receiving new text messages, you can also press the **View** soft key to read the new messages directly.

**To send a text message:**

1. Press **Menu->Message->Text Message->New Message**.
2. Compose the new text message. You can press the **abc** soft key to change the input mode.



3. Press the **Send** soft key after completing the content.
4. Enter the number you want to send the message to in the **To** field.
5. Press the **Send** soft key to send the message or the **Back** soft key to cancel.

Sending a text message is configurable via web user interface at the path **Features->SMS**.

**To reply a text message:**

1. Press **Menu->Message->Text Message->Inbox**.
2. Select the desired message and then press the **Reply** soft key.
3. Compose the new text message. You can press the **abc** soft key to change the input mode.



4. Press the **Send** soft key after completing the content.

5. Check the **From** and **To** fields, and then press the **Send** soft key.

**To delete a text message:**

1. Press **Menu->Message->Text Message->Inbox (Sentbox, Outbox or Draftbox)**.
2. Select the desired message and then press the **Delete** soft key.



3. Select **Delete** to delete the desired message, then press the **OK** soft key.

The LCD screen prompts "Delete the selected message?".



4. Press the **OK** soft key to delete this message or the **Cancel** soft key to cancel.

You can also delete all text messages by pressing the **Delete** soft key and then select **Delete All**. For more information, refer to the above steps.

**Note**

You can also delete a specific message by pressing the **Delete** soft key after viewing.

## Voice Mail

You can leave voice mails for someone else using the SIP-T19(P) E2 IP phone. You can also listen to voice mails that are stored in a voice mailbox. This feature is set up on the server side. It is not available on all servers.

When receiving a new voice mail, the phone will play a warning tone. The power indicator LED will slowly flash yellow, and the LCD screen will prompt "n New Voice Mail(s)" ("n" indicates the number of unread voice messages. e.g., 164 New Voice Mail(s)) and a flashing icon  .

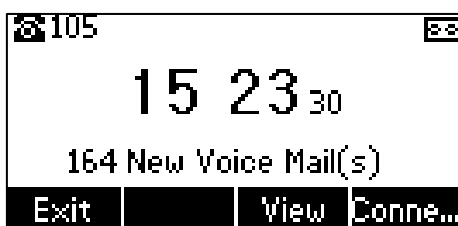

If the voice mail pop-up message box disappears, it won't pop up again unless the user receives a new voice mail or the user re-registers the account that has unread voice mail(s).

**Note**

You can configure the phone not to display the pop-up prompt, contact your system administrator for more information.

**To leave a voice mail:**

You can leave a voice mail for someone else when he/she is busy or inconvenient to answer the call. Follow the voice prompt from the system server to leave a voice mail, and then hang up.

**To configure voice mail access codes via phone user interface:**

1. Press **Menu->Message->Voice Mail->Set Voice Mail Code**.
2. Press the navigation keys to highlight the account which you want to set.
3. Press the **123** soft key to select the proper input mode and then enter the voice mail access code (e.g., \*97).

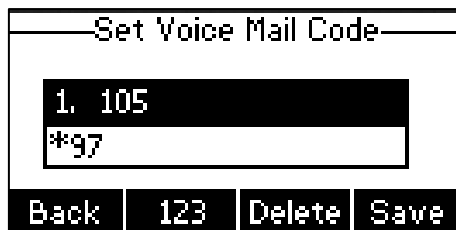

4. Press the **Save** soft key to accept the change or the **Back** soft key to cancel.

**Note**

Voice mail access codes must be predefined on the system server. Contact your system administrator for the more information.

**To listen to voice mails:**

1. When the LCD screen prompts that the phone receives a new voice mail and the power indicator LED slowly flashes yellow, you can press  or the **Connect** soft key to dial out the voice mail access code.
2. Follow the voice prompt to listen to your voice mails.

**Note**

Before listening to voice mails, make sure the voice mail access code has been configured. When all new voice mails are retrieved, the power indicator LED will go out.

**To view the voice mail via phone user interface:**

1. Press **Menu->Message->Voice Mail->View Voice Mail**.

- The LCD screen displays the amount of new and old voice mails.

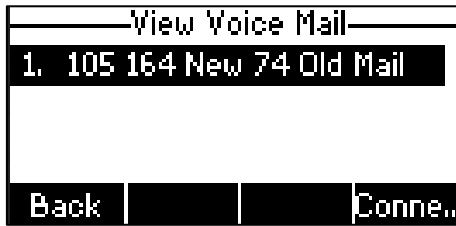

- Press the **Connect** soft key to listen to voice mails.

## Message Waiting Indicator (MWI)

The SIP-T19(P) E2 IP phone supports MWI when receiving a new voice message. If someone leaves you a voice mail, you will receive a message waiting indicator. MWI will be indicated in three ways: a warning tone, an indicator message (including a voice mail icon) on the LCD screen, and the power indicator LED slowly flashes yellow. This will be cleared when you retrieve all voice mails or delete them.

The MWI service is unsolicited for some servers, so the SIP-T19(P) E2 IP phone only handles the MWI messages sent from the server. But for other servers, the MWI service is solicited, so the SIP-T19(P) E2 IP phone must enable subscription for MWI.

**Note**

MWI service is not available on all servers. Contact your system administrator for more information.

The MWI subscription parameters you need to know:

Options	Description
<b>Subscribe for MWI</b>	Enable or disable a subscription for MWI service.
<b>MWI Subscription Period</b>	Period of MWI subscription. The IP phone sends a refresh SUBSCRIBE request before initial SUBSCRIBE expiration.
<b>Subscribe MWI To Voice Mail</b>	Enable or disable a subscription to the voice mail number for MWI service. To use this feature, you should also configure the voice mail number.

**Note**

The phone will send SUBSCRIBE messages for the MWI service to the account or the voice number MWI service depending on the server. Contact your system administrator for more information.

**To configure subscribe for MWI via web user interface:**

- Click on **Account->Advanced**.



2. Select **Enabled** from the pull-down list of **Subscribe for MWI** field.
3. Enter the period time in the **MWI Subscription Period(Seconds)** field.

The screenshot shows the Yealink T19 E2 web interface. The 'Account' tab is selected, and the 'Advanced' sub-tab is active. The following settings are visible:

Field	Value
Keep Alive Type	Default
Keep Alive Interval(Seconds)	30
RPort	Disabled
Subscribe Period(Seconds)	1800
DTMF Type	RFC2833
DTMF Info Type	DTMF-Relay
DTMF Payload Type(96~127)	101
BLF Send DTMF	Disabled
BLF DTMF Code	
Retransmission	Disabled
Subscribe Register	Disabled
Subscribe for MWI	Enabled
MWI Subscription Period(Seconds)	3600
Subscribe MWI To Voice Mail	Enabled
Voice Mail	*4
Voice Mail Display	Enabled
Caller ID Source	FROM
Session Timer	Disabled

A red box highlights the 'Subscribe for MWI' and 'MWI Subscription Period(Seconds)' fields. The 'Voice Mail' field is also highlighted with a red box.

4. Click **Confirm** to accept the change.  
The IP phone will subscribe to the account number for MWI service by default.

**To enable subscribe MWI to voice mail via web user interface:**

1. Click on **Account->Advanced**.
2. Select **Enabled** from the pull-down list of **Subscribe for MWI**.
3. Select **Enabled** from the pull-down list of **Subscribe MWI To Voice Mail**.
4. Enter the desired voice mail number in the **Voice Mail** field.

The screenshot shows the Yealink T19 E2 web interface. The 'Account' tab is selected, and the 'Advanced' sub-tab is active. The following settings are visible:

Field	Value
Keep Alive Type	Default
Keep Alive Interval(Seconds)	30
RPort	Disabled
Subscribe Period(Seconds)	1800
DTMF Type	RFC2833
DTMF Info Type	DTMF-Relay
DTMF Payload Type(96~127)	101
BLF Send DTMF	Disabled
BLF DTMF Code	
Retransmission	Disabled
Subscribe Register	Disabled
Subscribe for MWI	Enabled
MWI Subscription Period(Seconds)	3600
Subscribe MWI To Voice Mail	Enabled
Voice Mail	*4
Voice Mail Display	Enabled
Caller ID Source	FROM
Session Timer	Disabled

Red boxes highlight the 'Subscribe for MWI', 'MWI Subscription Period(Seconds)', and 'Voice Mail' fields.

5. Click **Confirm** to accept the change.

The IP phone will subscribe to the voice mail number for MWI service using Subscribe MWI To Voice Mail.

**Note**

MWI subscription is configurable via web user interface only.

## Regulatory Notices

### Service Agreements

Contact your Yealink Authorized Reseller for information about service agreements applicable to your product.

### Limitations of Liability

TO THE FULL EXTENT ALLOWED BY LAW, YEALINK EXCLUDES FOR ITSELF AND ITS SUPPLIERS ANY LIABILITY, WHETHER BASED IN CONTRACT OR TORT (INCLUDING NEGLIGENCE), FOR INCIDENTAL, CONSEQUENTIAL, INDIRECT, SPECIAL, OR PUNITIVE DAMAGES OF ANY KIND, OR FOR LOSS OF REVENUE OR PROFITS, LOSS OF BUSINESS, LOSS OF INFORMATION OR DATA, OR OTHER FINANCIAL LOSS ARISING OUT OF OR IN CONNECTION WITH THE SALE, INSTALLATION, MAINTENANCE, USE, PERFORMANCE, FAILURE, OR INTERRUPTION OF ITS PRODUCTS, EVEN IF YEALINK OR ITS AUTHORIZED RESELLER HAS BEEN ADVISED OF THE POSSIBILITY OF SUCH DAMAGES, AND LIMITS ITS LIABILITY TO REPAIR, REPLACEMENT, OR REFUND OF THE PURCHASE PRICE PAID, AT YEALINK'S OPTION. THIS DISCLAIMER OF LIABILITY FOR DAMAGES WILL NOT BE AFFECTED IF ANY REMEDY PROVIDED HEREIN SHALL FAIL OF ITS ESSENTIAL PURPOSE.

### Safety Instructions

**Save these instructions. Read these safety instructions before use!**

The following basic safety precautions should always be followed to reduce risk of fire, electrical shock, and other personal injury.



#### General Requirements

- Before you install and use the device, read the safety instructions carefully and observe the situation during operation.
- During the process of storage, transportation, and operation, please always keep the device dry and clean.
- During the process of storage, transportation, and operation, please avoid collision and crash of the device.
- Please attempt not to dismantle the device by yourself. In case of any discrepancy, please contact the appointed maintenance center for repair.
- Without prior written consent, no organization or individual is permitted to make any change to the structure or the safety design of the device. Yealink is under no circumstance liable to consequences or legal issues caused by such changes.
- Please refer to the relevant laws and statutes while using the device. Legal rights of others should be respected as well.



#### Environmental Requirements

- Place the device at a well-ventilated place. Do not expose the device under direct sunlight.
- Keep the device dry and free of dusts.
- Place the device on a stable and level platform.
- Please place no heavy objects on the device in case of damage and deformation caused by the heavy load.

- Keep at least 10 cm between the device and the closest object for heat dissipation.
- Do not place the device on or near any inflammable or fire-vulnerable object, such as rubber-made materials.
- Keep the device away from any heat source or bare fire, such as a candle or an electric heater.
- Keep the device away from any household appliance with strong magnetic field or electromagnetic field, such as a microwave oven or a refrigerator.

### **Operating Requirements**

- Do not let a child operate the device without guidance.
- Do not let a child play with the device or any accessory in case of accidental swallowing.
- Please use the accessories provided or authorized by the manufacturer only.
- The power supply of the device shall meet the requirements of the input voltage of the device. Please use the provided surge protection power socket only.
- Before plugging or unplugging any cable, make sure that your hands are completely dry.
- Do not spill liquid of any kind on the product or use the equipment near water, for example, near a bathtub, washbowl, kitchen sink, wet basement or near a swimming pool.
- Do not tread on, pull, or over-bend any cable in case of malfunction of the device.
- During a thunderstorm, stop using the device and disconnect it from the power supply. Unplug the power plug and the Asymmetric Digital Subscriber Line (ADSL) twisted pair (the radio frequency cable) to avoid lightning strike.
- If the device is left unused for a rather long time, disconnect it from the power supply and unplug the power plug.
- When there is smoke emitted from the device, or some abnormal noise or smell, disconnect the device from the power supply, and unplug the power plug immediately. Contact the specified maintenance center for repair.
- Do not insert any object into equipment slots that is not part of the product or auxiliary product.
- Before connecting a cable, connect the grounding cable of the device first. Do not disconnect the grounding cable until you disconnect all other cables.

### **Cleaning Requirements**

- Before cleaning the device, stop using it and disconnect it from the power supply.
- Use a piece of soft, dry and anti-static cloth to clean the device.
- Keep the power plug clean and dry. Using a dirty or wet power plug may lead to electric shock or other perils.

## Appendix

### Appendix A - Time Zones

Time Zone	Time Zone Name
-11	Samoa
-10	United States-Hawaii-Aleutian, United States-Alaska-Aleutian
-9:30	French Polynesia
-9	United States-Alaska Time
-8	Canada(Vancouver,Whitehorse), Mexico(Tijuana,Mexicali), United States-Pacific Time
-7	Canada(Edmonton,Calgary), Mexico(Mazatlan,Chihuahua), United States-MST no DST, United States-Mountain Time
-6	Canada-Manitoba(Winnipeg), Chile(Easter Islands), Mexico(Mexico City,Acapulco), United States-Central Time
-5	Bahamas(Nassau), Canada(Montreal,Ottawa,Quebec), Cuba(Havana), United States-Eastern Time
-4:30	Venezuela(Caracas)
-4	Canada(Halifax,Saint John), Chile(Santiago), Paraguay(Asuncion), United Kingdom-Bermuda(Bermuda), United Kingdom(Falkland Islands), Trinidad&Tobago
-3:30	Canada-New Foundland(St.Johns)
-3	Argentina(Buenos Aires), Brazil(DST), Brazil(no DST), Denmark-Greenland(Nuuk)
-2:30	Newfoundland and Labrador
-2	Brazil(no DST)
-1	Portugal(Azores)
0	Denmark-Faroe Islands(Torshavn), GMT, Greenland, Ireland(Dublin), Morocco, Portugal(Lisboa,Porto,Funchal), Spain-Canary Islands(Las Palmas), United Kingdom(London)
+1	Albania(Tirane), Austria(Vienna), Belgium(Brussels), Caicos, Chad, Croatia(Zagreb), Czech Republic(Prague), Denmark(Kopenhagen), France(Paris), Germany(Berlin), Hungary(Budapest), Italy(Rome), Luxembourg(Luxembourg), Macedonia(Skopje), Namibia(Windhoek), Netherlands(Amsterdam), Spain(Madrid)
+2	Estonia(Tallinn), Finland(Helsinki), Gaza Strip(Gaza), Greece(Athens), Israel(Tel Aviv), Jordan(Amman), Latvia(Riga), Lebanon(Beirut), Moldova(Kishinev), Romania(Bucharest), Russia(Kaliningrad), Syria(Damascus), Turkey(Ankara), Ukraine(Kyiv, Odessa)
+3	East Africa Time, Iraq(Baghdad), Russia(Moscow)
+3:30	Iran(Teheran)
+4	Armenia(Yerevan), Azerbaijan(Baku), Georgia(Tbilisi), Kazakhstan(Aktau), Russia(Samara)
+4:30	Afghanistan(Kabul)
+5	Kazakhstan(Aqtobe), Kyrgyzstan(Bishkek), Pakistan(Islamabad), Russia(Chelyabinsk)
+5:30	India(Calcutta)
+5:45	Nepal(Katmandu)
+6	Kazakhstan(Astana, Almaty), Russia(Novosibirsk,Omsk)
+6:30	Myanmar(Naypyitaw)
+7	Russia(Krasnoyarsk), Thailand(Bangkok)
+8	Australia(Perth), China(Beijing), Russia(Irkutsk, Ulan-Ude), Singapore(Singapore)
+8:45	Eucla

<b>Time Zone</b>	<b>Time Zone Name</b>
+9	Japan(Tokyo), Korea(Seoul), Russia(Yakutsk,Chita)
+9:30	Australia(Adelaide), Australia(Darwin)
+10	Australia(Brisbane), Australia(Hobart), Australia(Sydney,Melboume,Canberra), Russia(Vladivostok)
+10:30	Australia(Lord Howe Islands)
+11	New Caledonia(Noumea), Russia(Srednekolymsk Time)
+11:30	Norfolk Island
+12	New Zealand(Wellington,Auckland), Russia(Kamchatka Time)
+12:45	New Zealand(Chatham Islands)
+13	Tonga(Nukualofa)
+13:30	Chatham Islands
+14	Kiribati

## Appendix B – Menu Structure

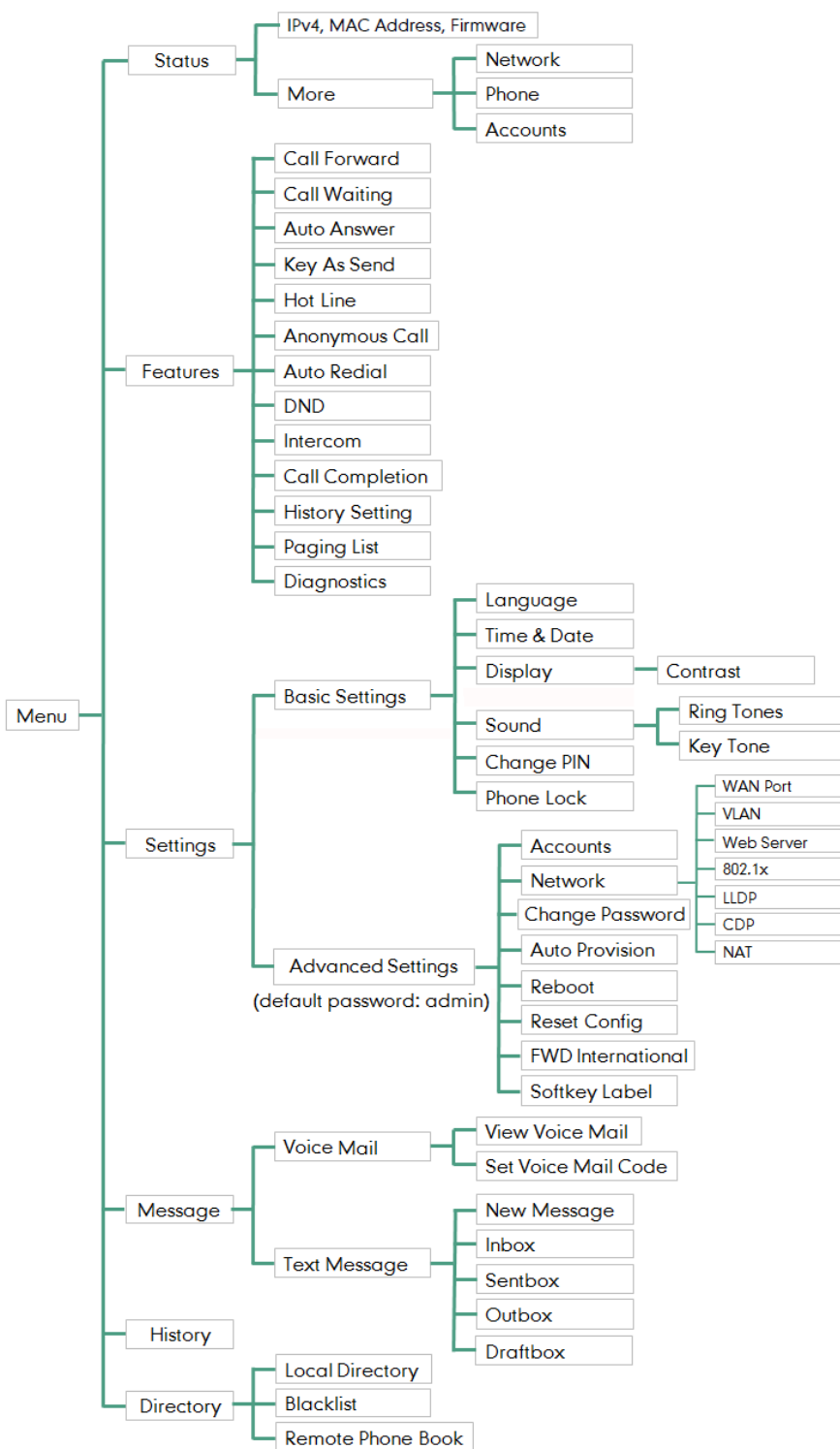





# Index

## A

About This Guide v  
 Accessing the Remote Phone Book 44  
 Account Registration 57  
 Adding a Contact to the Local Directory/Blacklist 46  
 Adding Contacts 36  
 Adding Groups 33  
 Administrator password 24  
 Advanced Phone Features 99  
 Anonymous Call 96  
 Anonymous Call Rejection 97  
 Answering Calls 67  
 Appendix A - Time Zones 129  
 Area Code 61  
 Attended Transfer 84  
 Audio Settings 28  
 Auto Answer 70  
 Auto Redial 70

## B

Basic Call Features 65  
 Basic Network Settings 16  
 Blacklist 42  
 Blind Transfer 82  
 Block Out 62  
 Bridged Line Appearance (BLA) 115

## C

Call Completion 72  
 Call Forward 78  
 Call History Management 45  
 Call Hold/Resume 75  
 Call Mute 73  
 Call Park/Retrieve 88  
 Call Pickup 92  
 Call Transfer 81  
 Call Waiting 85  
 CE Mark Warning ii  
 Configuring an Access URL 44  
 Configuring an Intercom Key 101  
 Configuring BLA Feature on the IP Phone 116  
 Configuring SCA Feature on the IP Phone 111  
 Conference 86  
 Contact Management 31  
 Contrast 21  
 Copyright ii  
 Customizing Your Phone 21

## D

Declaration of Conformity ii  
 Deleting Contacts 38  
 Deleting Groups 35  
 Deleting History Records 46  
 Dial Now 59  
 Dial Plan 57  
 Directory 32  
 Disabling History Record 47  
 Do Not Disturb (DND) 76  
 Documentations 8  
 Dual Headset 51  
 Dynamic Forwarding 81

## E

Editing Contacts 37  
 Editing Groups 34  
 Emergency Number 62  
 Ending Calls 68  
 Entering Data and Editing Fields 18

## F

Features Status Icons 3

## G

General Settings 21  
 Getting Started 9

## H

Hardware Component Instructions 1  
 Headset Mode Activation/Deactivation 50  
 Headset Prior 50  
 Headset Use 49  
 Hot Desking 99  
 Hotline 64

## I

Icon Instructions 3  
 Idle Screen 18  
 Importing/Exporting Contact lists 40  
 Incoming Intercom Call 101  
 In This Guide v  
 Intercom 101

## K

Key As Send 25  
 Key Tone 31

## L

Language [22](#)  
 LED Instructions [4](#)  
 Limitation of Liability [127](#)  
 Live Dialpad [63](#)  
 Local Conference [86](#)  
 Local Directory [33](#)  
 Logo Customization [49](#)

## M

Messages [120](#)  
 Message Waiting Indicator [124](#)  
 Multicast Paging [103](#)  
 Music on Hold (MoH) [109](#)  
 Muting a Call [74](#)  
 Muting While Dialing [74](#)

## N

Network Conference [87](#)

## O

Optional Accessories [10](#)  
 Other Icons [4](#)  
 Overview [1](#)

## P

Packaging Contents [9](#)  
 Phone Initialization [14](#)  
 Phone Installation [11](#)  
 Phone Status [14](#)  
 Phone User Interface [5](#)  
 Placing a Call from History Records [46](#)  
 Placing Calls [65](#)  
 Placing Calls to Contacts [39](#)  
 Phone Lock [25](#)  
 Programable Keys [51](#)

## R

Recall [73](#)  
 Receiving RTP Stream [106](#)  
 Recent Call In Dialing [69](#)  
 Redialing Numbers [68](#)  
 Registration [17](#)  
 Regulatory Notices [127](#)  
 Remote Phone Book [43](#)  
 Replace Rule [58](#)  
 Ring Tones [29](#)

## S

Safety Instructions [127](#)  
 Search Source List in Dialing [47](#)  
 Searching for Contacts [39](#)  
 Semi-attended Transfer [84](#)

Sending RTP Stream [104](#)  
 Service Agreements [127](#)  
 Shared Call Appearance (SCA) [110](#)  
 Short Message Service (SMS) [120](#)  
 Static Forwarding [78](#)  
 Summary of Changes [v](#)  
 System Customizations [49](#)

## T

Table of Contents [viii](#)  
 Time & Date [22](#)

## U

User Interfaces [5](#)  
 Using BLA Features on the IP Phone [119](#)  
 Using Intercom [103](#)  
 Using Multicast Paging [108](#)  
 Using SCA Features on the IP Phone [114](#)

## V

Viewing History Records [45](#)  
 Voice Mail [122](#)  
 Volume [28](#)

## W

Warranty [ii](#)  
 Web User Interface [6](#)  
 WEEE Warning [iii](#)